

EZO-RTD™

Embedded Temperature Circuit

Reads	Temperature
Range	-126.000 °C – 1254 °C
Resolution	0.001
Accuracy	+/- (0.10°C + 0.0017 x °C)
Response time	1 reading per sec
Supported probes	Any type & brand PT-100 or PT-1000 RTD
Calibration	Single point
Temperature output	°C, °K, or °F
Data protocol	UART & I²C
Default I ² C address	102 (0x66)
Operating voltage	3.3V – 5.5V
Data format	ASCII
Onboard Data Logger	50 Readings

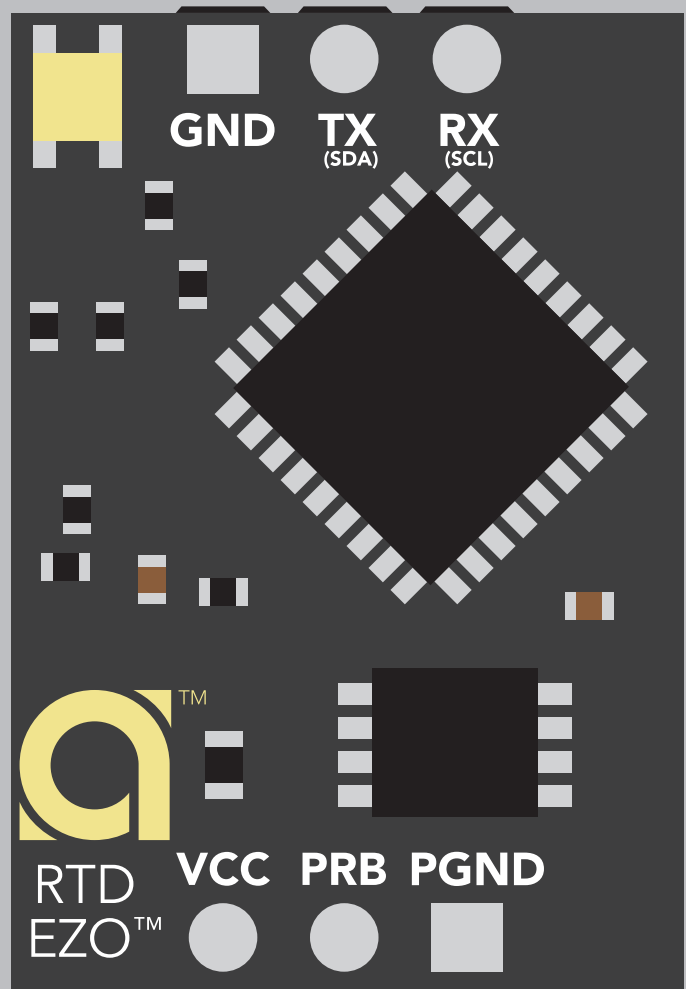

Electrical Isolation not needed





STOP

SOLDERING THIS DEVICE VOIDS YOUR WARRANTY.

This is sensitive electronic equipment. Get this device working in a solderless breadboard first. Once this device has been soldered it is no longer covered by our warranty.

This device has been designed to be soldered and can be soldered at any time. Once that decision has been made, Atlas Scientific no longer assumes responsibility for the device's continued operation. The embedded systems engineer is now the responsible party.

Get this device working in a solderless breadboard first!

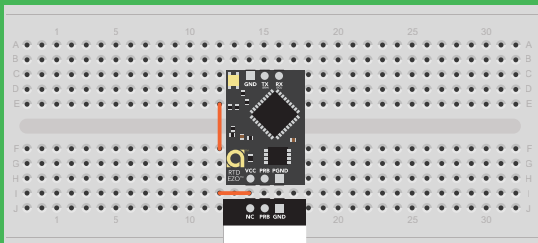

Do not embed this device without testing it in a solderless breadboard!

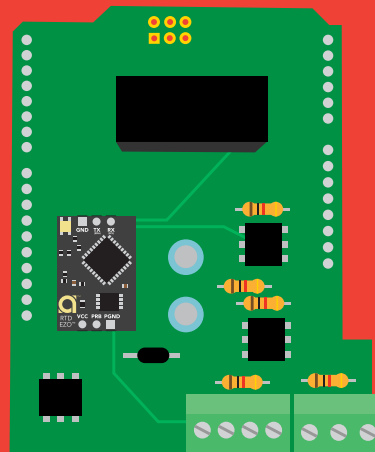

Table of contents

Circuit dimensions	4	Using other brand PT-100/PT-1000	7
Power consumption	4	Operating principle	8
Absolute max ratings	4	Correct wiring	10
Temperature circuit range	5	Calibration theory	11
Temperature circuit accuracy	5	On board data logger	12
Atlas Scientific PT-1000 probe	6	Available data protocols	13

UART

UART mode	15
Default state	16
Receiving data from device	17
Sending commands to device	18
LED color definition	19
UART quick command page	20
LED control	21
Find	22
Continuous reading mode	23
Single reading mode	24
Calibration	25
Export calibration	26
Import calibration	27
Temperature scale	28
Enable/disable data logger	29
Memory recall	30
Memory clear	31
Naming device	32
Device information	33
Response codes	34
Reading device status	35
Sleep mode/low power	36
Change baud rate	37
Protocol lock	38
Factory reset	39
Change to I ² C mode	40
Manual switching to I ² C	41

I²C

I ² C mode	43
Sending commands	44
Requesting data	45
Response codes	46
LED color definition	47
I²C quick command page	48
LED control	49
Find	50
Taking reading	51
Calibration	52
Export calibration	53
Import calibration	54
Temperature scale	55
Enable/disable data logger	56
Memory recall	57
Memory clear	58
Device information	59
Reading device status	60
Sleep mode/low power	61
Protocol lock	62
I ² C address change	63
Factory reset	64
Change to UART mode	65
Manual switching to UART	66

Circuit footprint	67
Datasheet change log	68
Warranty	70

EZO™ circuit dimensions

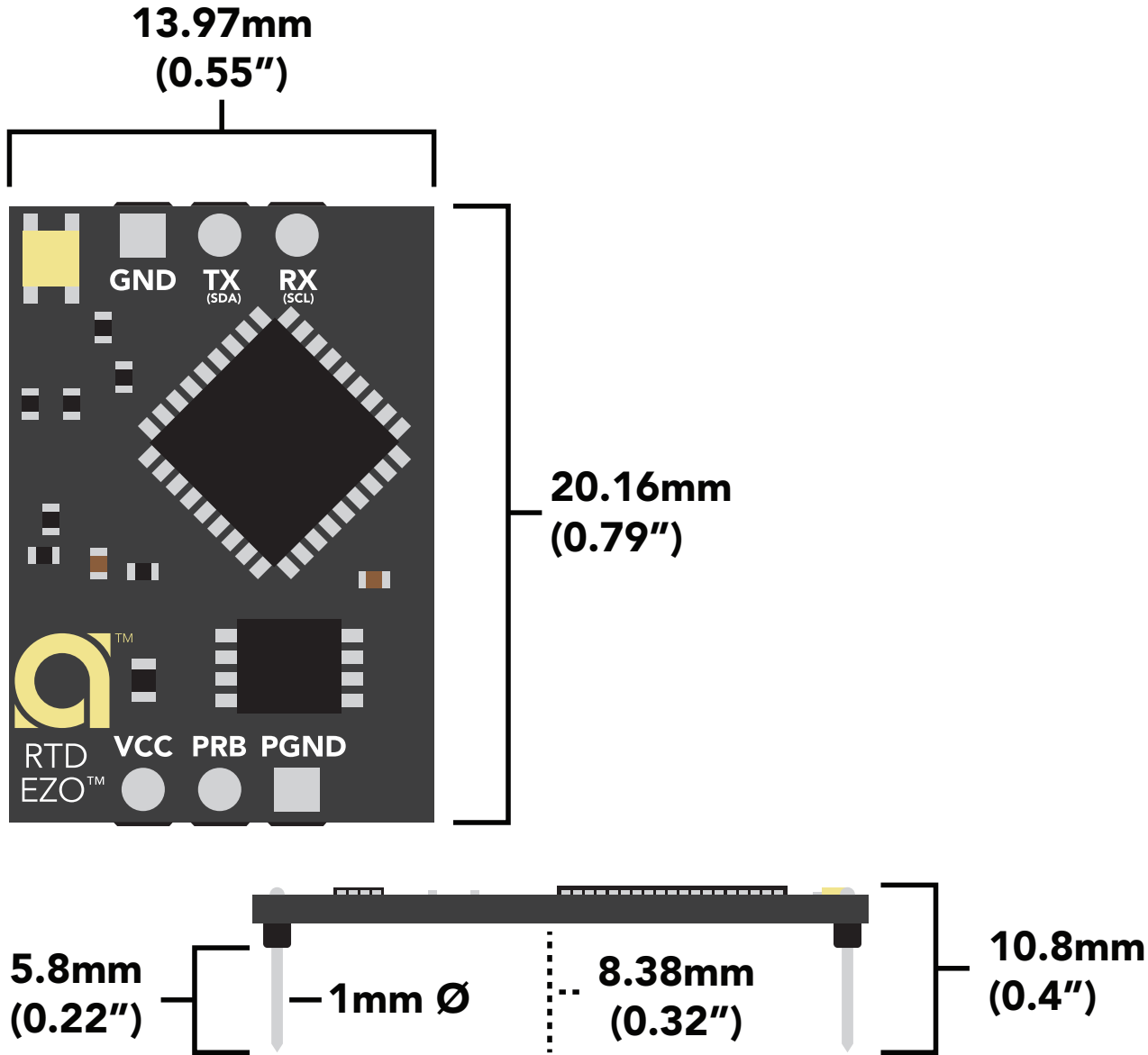

Power consumption

	LED	MAX	STANDBY	SLEEP
5V	ON	16 mA	15.4 mA	0.4 mA
	OFF	15.3 mA	15 mA	
3.3V	ON	14.3 mA	13.8 mA	0.09 mA
	OFF	14 mA	13.6 mA	

Absolute max ratings

Parameter	MIN	TYP	MAX
Storage temperature (EZO™ RTD)	-65 °C		125 °C
Operational temperature (EZO™ RTD)	-40 °C	25 °C	85 °C
VCC	3.3V	5V	5.5V

EZO™ RTD temperature sensing range

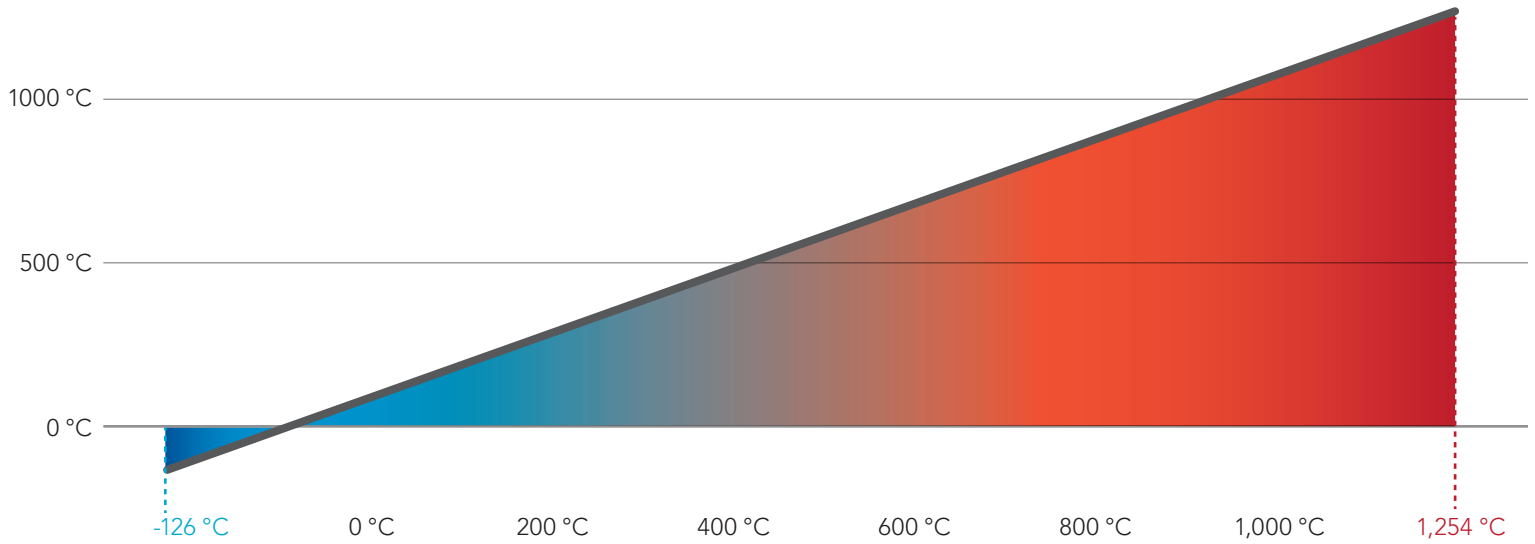

EZO™ RTD temperature sensing accuracy

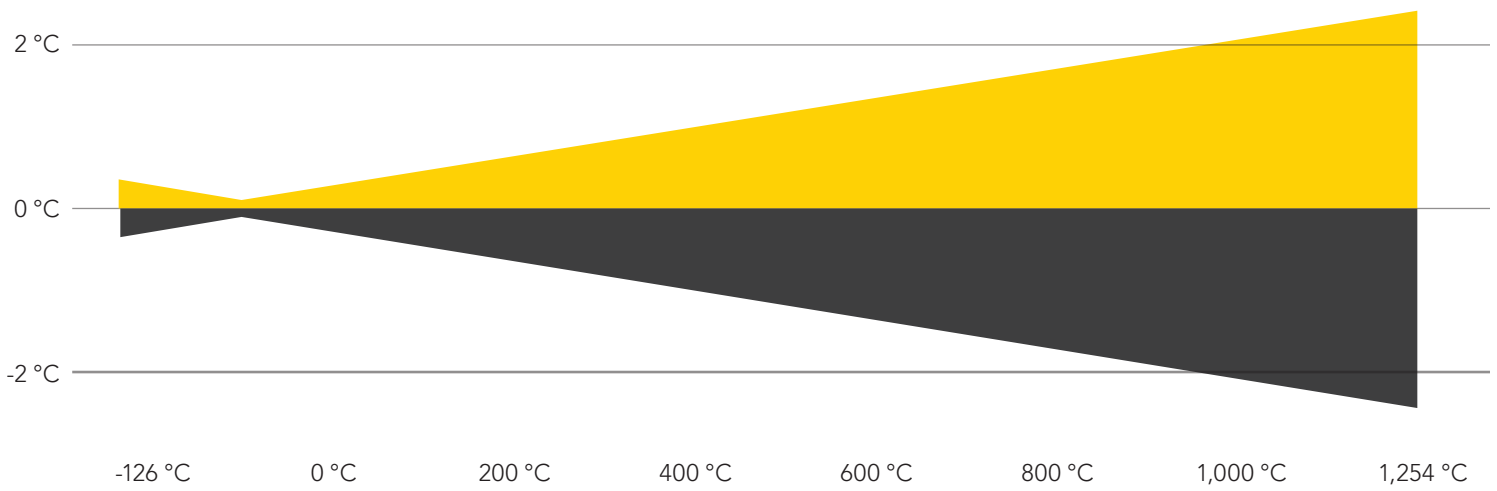

Atlas Scientific PT-1000 probe

- Accuracy +/- (0.15 + (0.002*t))
- Probe type: class A platinum, RTD
- Cable length: 81cm (32")
- Cable material: silicone rubber
- 30mm sensing area (304 SS)
- 6mm diameter
- BNC connector
- Reaction time: 90% value in 13 seconds
- Probe output: analog
- Full sensing range -200 °C to 850 °C
- Cable max temp 125 °C
- Cable min temp -55 °C

The Atlas Scientific EZO™ RTD Temperature circuit only works with PT-100 and PT-1000 probes.



To read temperatures above, or below the max cable temperature, an additional probe housing (thermowell) is needed to protect the cable.



100mm Temperature Thermowell

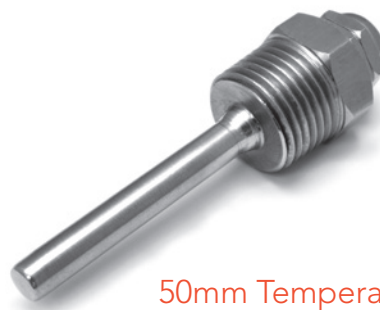

50mm Temperature Thermowell



30mm Temperature Thermowell

Using other brand PT-100/PT-1000

The EZO™ RTD Temperature circuit will auto-detect if the connected probe is PT-100 or PT-1000.

Probe class	Accuracy
AA	+/- (0.10°C + 0.0017 × T)
A	+/- (0.15°C + 0.002 × T)
B	+/- (0.3°C + 0.005 × T)
C	+/- (0.6°C + 0.01 × T)

It makes no difference which lead of the temperature probe is connected to the two probe pins.

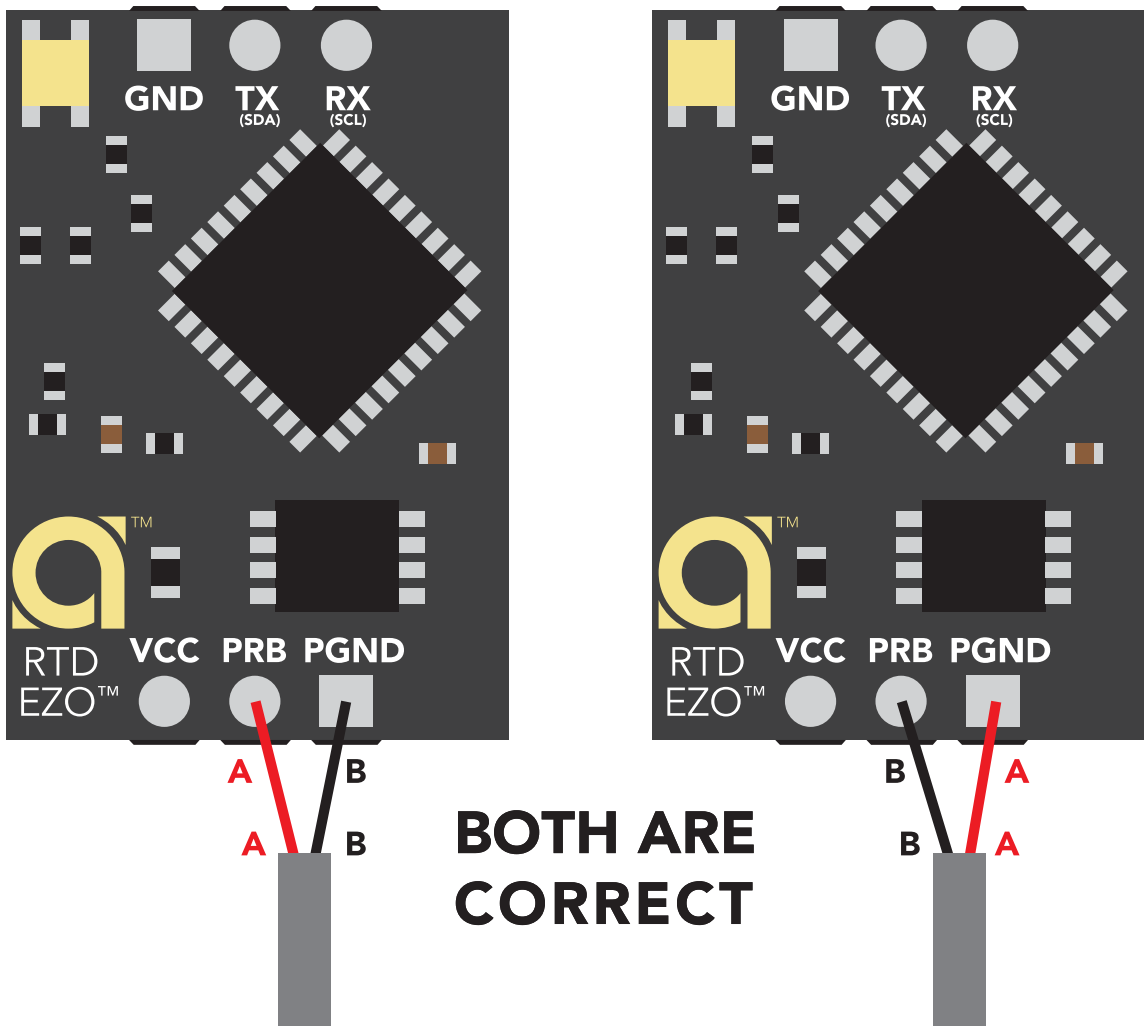

Operating principle

The Atlas Scientific EZO™ RTD Temperature circuit is a small footprint computer system that is specifically designed to be used in robotic applications where the embedded systems engineer requires accurate and precise measurements of temperature through a generic PT-100/PT-1000 temperature probe.

RTD = Resistance Temperature Detector

PT = Platinum

PT-100 = 100 Ω at 0°C

PT-1000 = 1k Ω at 0°C

Unlike any other material, platinum's correlation between resistance and temperature seems to be woven into the fabric of the universe. It is for this reason, that the platinum RTD temperature sensor is the industrial standard for temperature measurement.

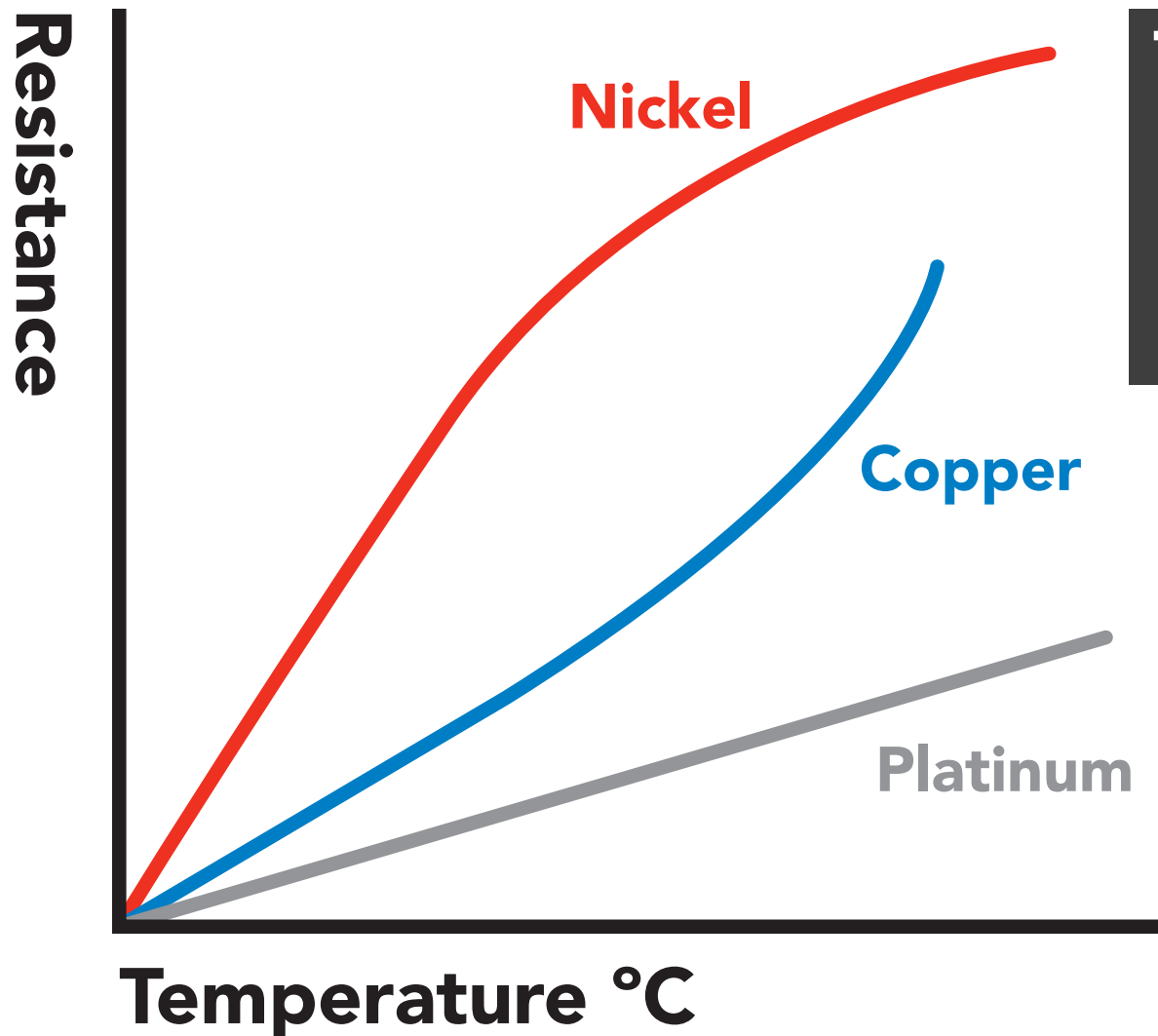

Power and data isolation

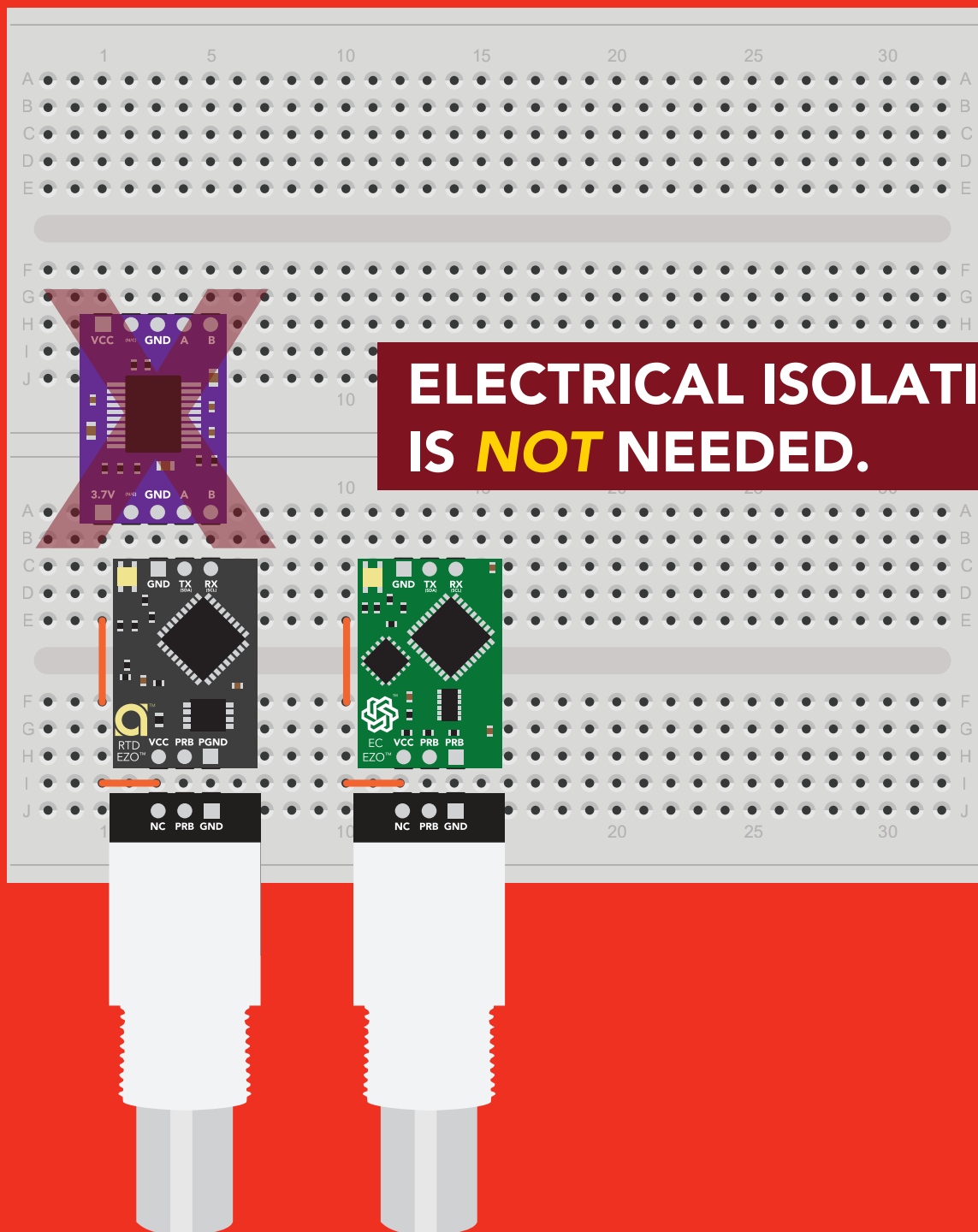

✓ Correct wiring

Bread board

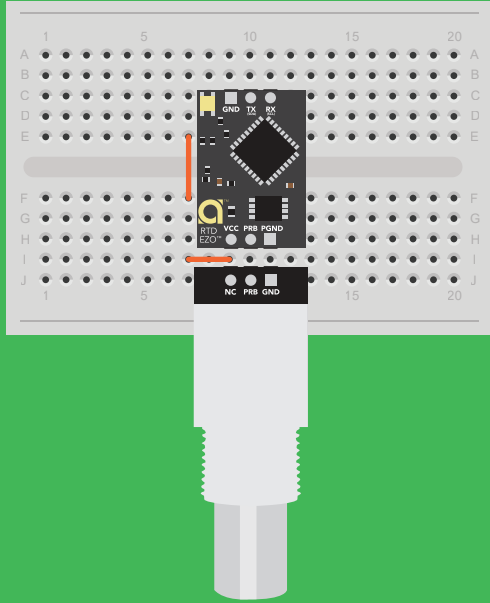

Bread board via USB

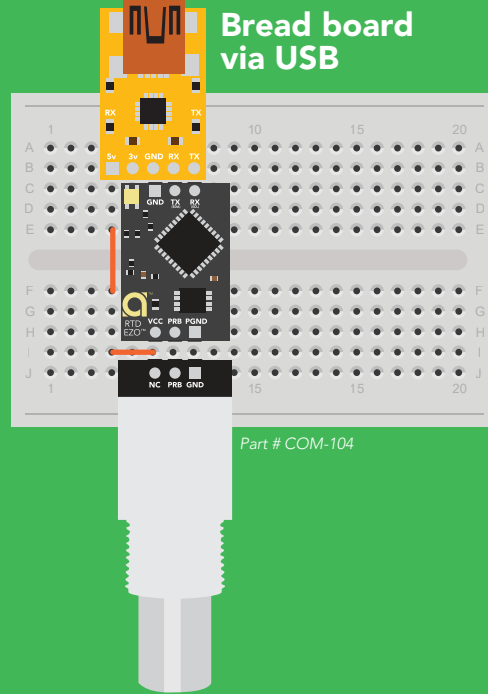

Carrier board



USB carrier board

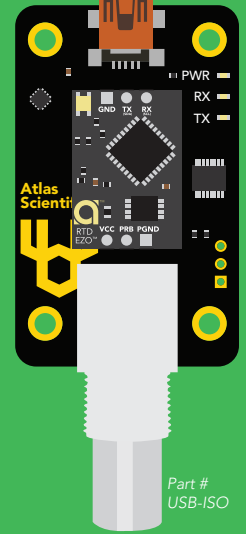

X Incorrect wiring

Extended leads

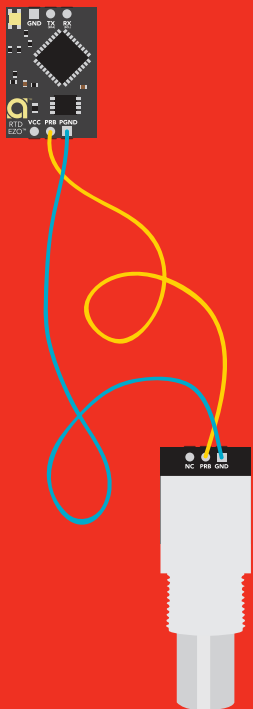

Sloppy setup

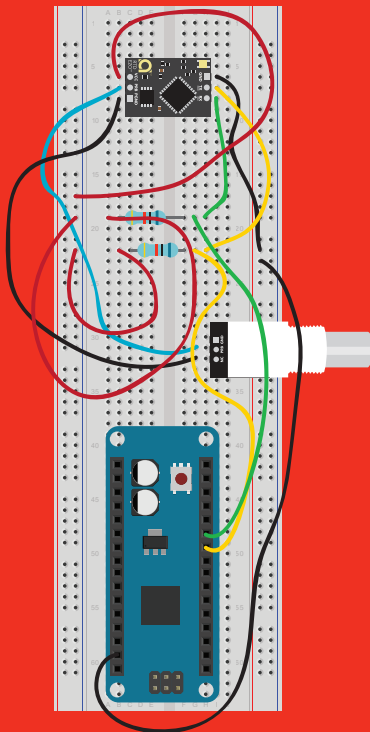

Perfboards or Protoboards

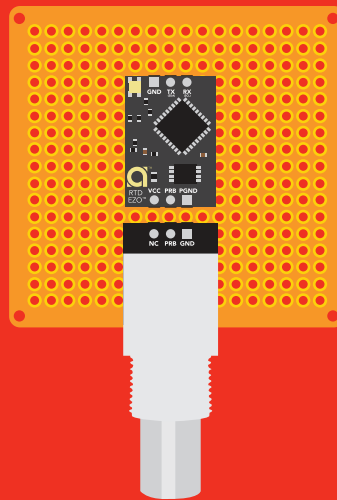

NEVER
use Perfboards
or Protoboards

*Embedded into your device

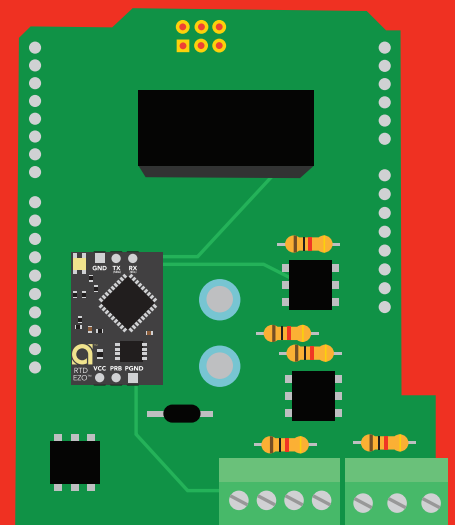

*Only after you are familiar
with EZO™ circuits operation

Calibration theory

The most important part of calibration is watching the readings during the calibration process. It's easiest to calibrate the device in its default state (UART mode, continuous readings). Switching the device to I²C mode after calibration **will not** affect the stored calibration. If the device must be calibrated in I²C mode be sure to request readings continuously so you can see the output from the probe.

Calibration can be done at any value, a simple method is to calibrate the probe in boiling water.

100 °C

Atlas Scientific recommends calibration be done every three years.

Elevation and boiling point table

Elevation in meters

305
229
152
76
0
-76
-152

Boiling point

98.9 °C
99.2 °C
99.5 °C
99.7 °C
100 °C
100.3 °C
100.5 °C

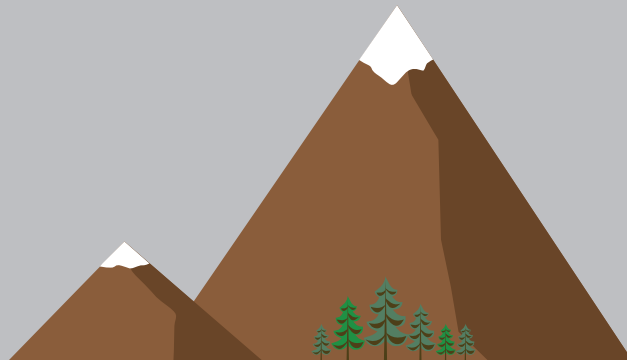

Use purified/distilled water

For accurate calibration using different temperature values, you must use a tool called a "dry block calibrator."

On board data logger

- 50 readings
- Programmable storage interval

Minimum – 10 seconds

Maximum – 320,000 seconds

Temperature readings that are stored to the data logger will be retained even if the power is cut.

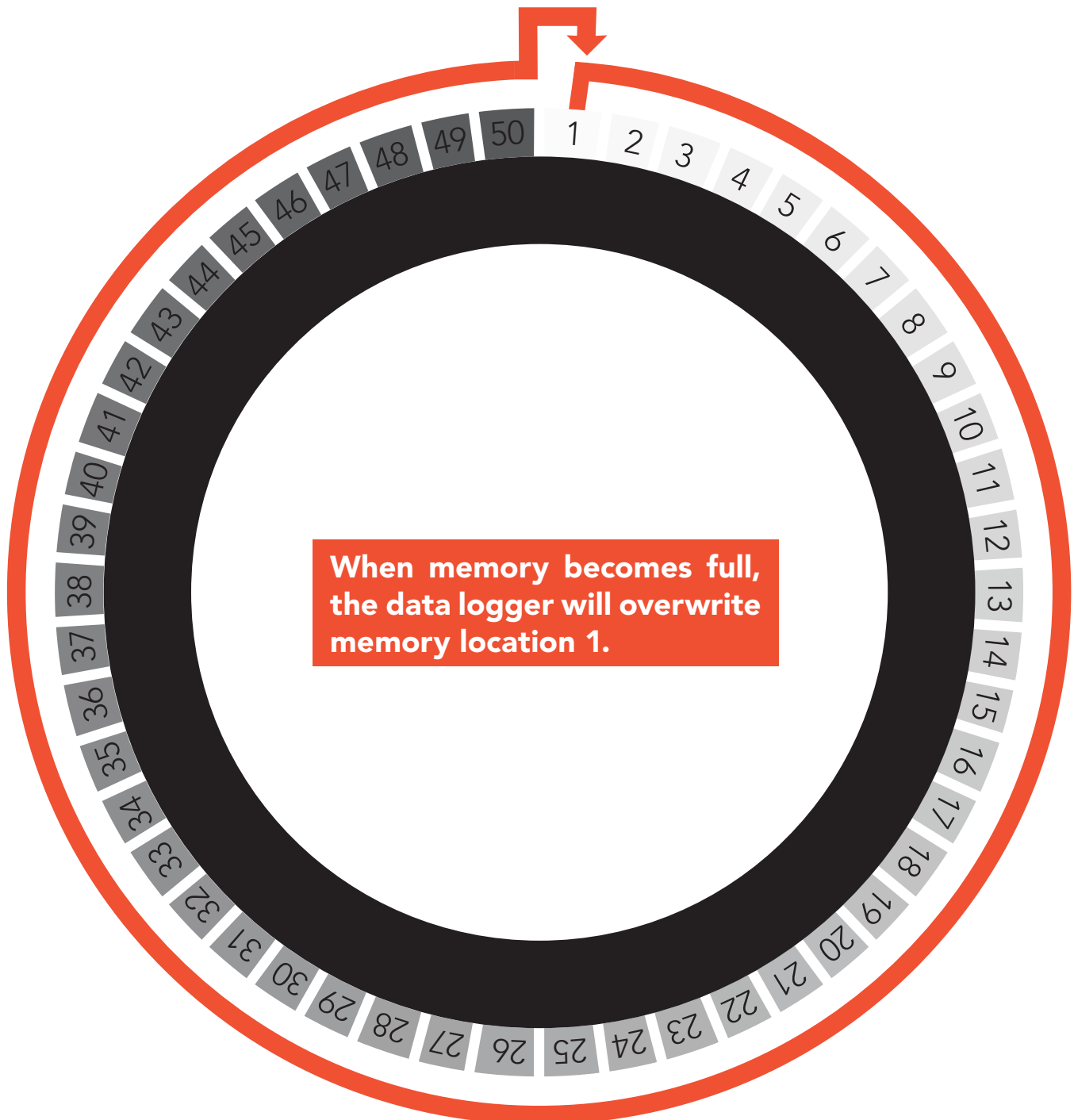

✓ Available data protocols

UART

Default

I²C

✗ Unavailable data protocols

SPI

Analog

RS-485

Mod Bus

4–20mA

UART mode

Settings that are retained if power is cut

- Baud rate
- Calibration
- Continuous mode
- Device name
- Enable/disable response codes
- Hardware switch to I²C mode
- LED control
- Protocol lock
- Software switch to I²C mode

Settings that are **NOT** retained if power is cut

- Find
- Sleep mode

UART mode

8 data bits no parity
1 stop bit no flow control

Baud 300
1,200
2,400
9,600 default
19,200
38,400
57,600
115,200



Vcc 3.3V – 5.5V

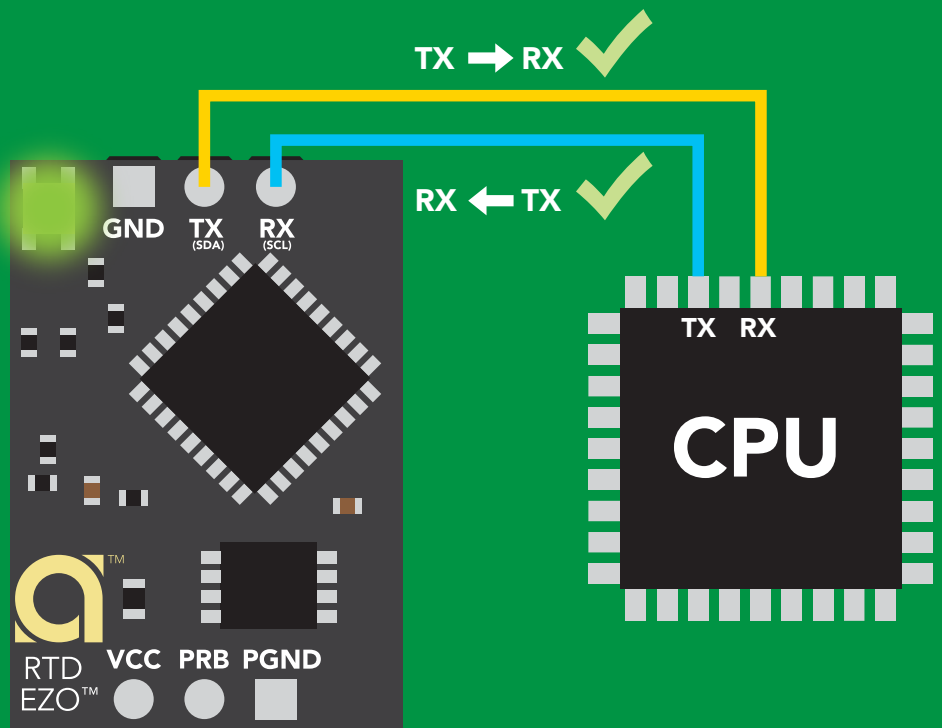

Data format

Reading	temperature	Data type	floating point
Units	°C, °K, or °F	Decimal places	3
Encoding	ASCII	Smallest string	4 characters
Format	string	Largest string	40 characters
Terminator	carriage return		

Default state

Mode	UART
Baud	9,600
Temperature	°C
Readings	continuous
Speed	1 reading per second
With probe	ttt.ttt
Without probe	-1023.000
LED	on

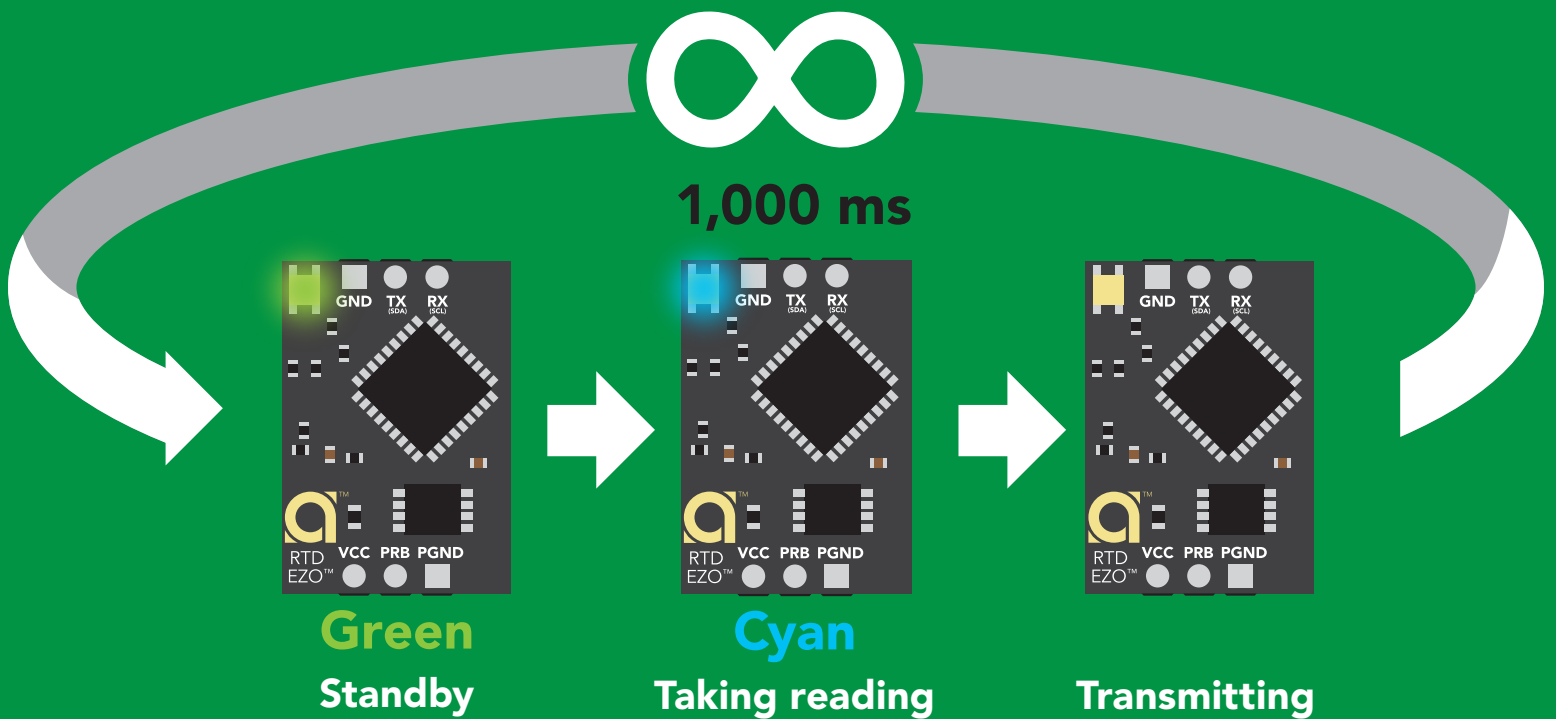

Receiving data from device

2 parts

ASCII data string

Command

Carriage return <cr>

Terminator

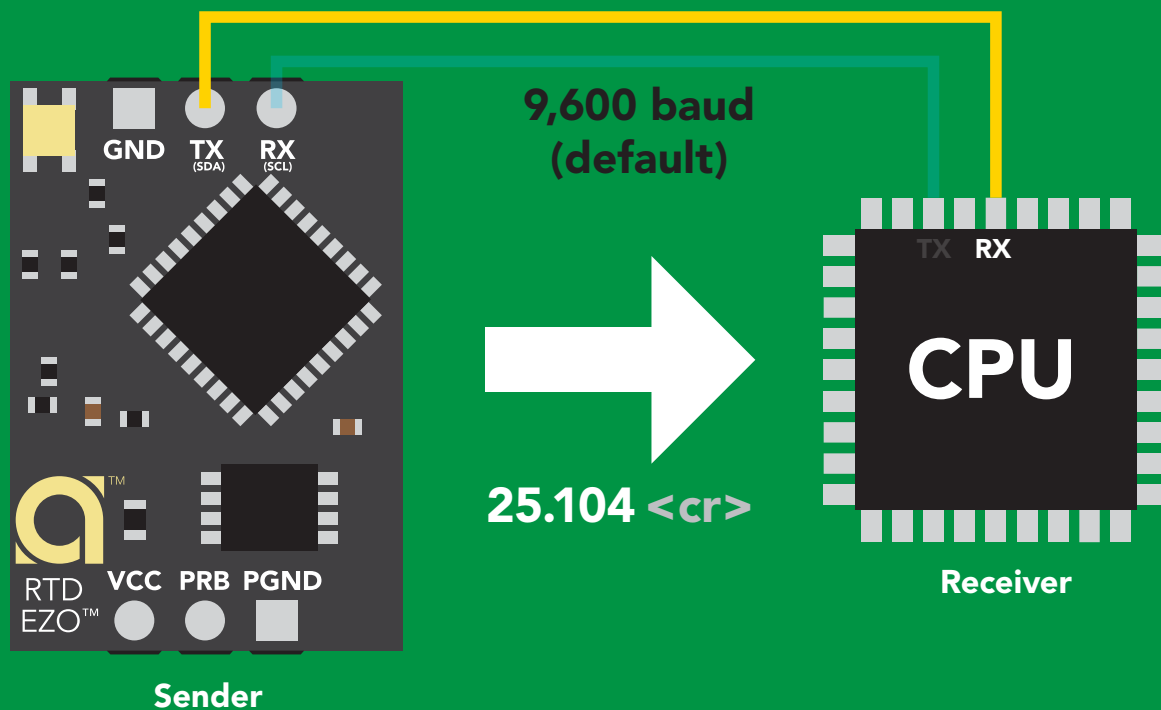

Advanced

ASCII: 2 5 . 1 0 4 <cr>

Hex: 32 35 2E 31 30 34 0D

Dec: 50 53 46 49 48 52 13

Sending commands to device

2 parts

Command (not case sensitive)

ASCII data string

Carriage return <cr>

Terminator

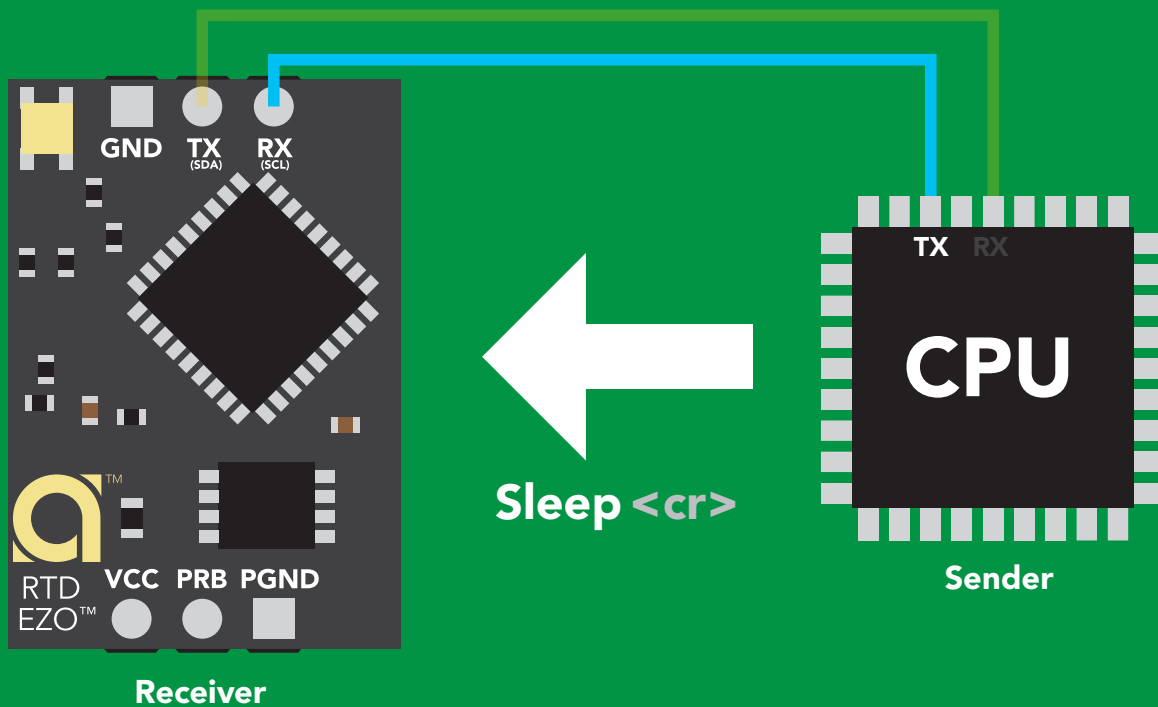

Advanced

ASCII: **S I e e p** <cr>

Hex: **53 6C 65 65 70** **0D**

Dec: **83 108 101 101 112** **13**

LED color definition

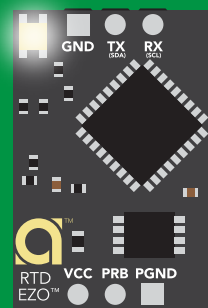
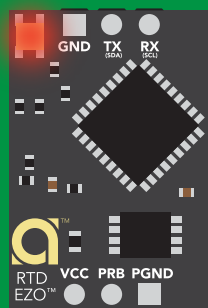
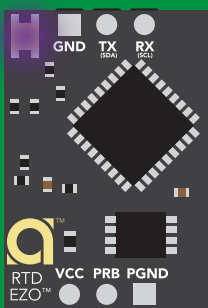
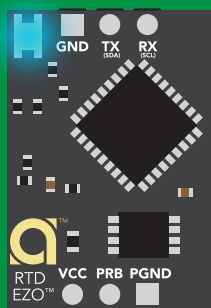
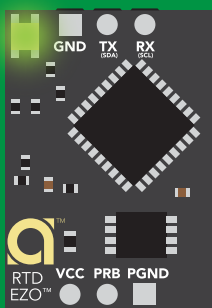

Green

UART standby

Cyan

Taking reading

Purple

Changing
baud rate

Red

Command
not understood

White

Find

5V

LED ON
+0.4 mA

3.3V

+0.2 mA

UART mode

command quick reference

All commands are ASCII strings or single ASCII characters.

Command	Function		Default state
Baud	change baud rate	pg. 37	9,600
C	enable/disable continuous reading	pg. 23	enabled
Cal	performs calibration	pg. 25	n/a
D	enable/disable data logger	pg. 29	disabled
Export	export calibration	pg. 26	n/a
Factory	enable factory reset	pg. 39	n/a
Find	finds device with blinking white LED	pg. 22	n/a
i	device information	pg. 33	n/a
I2C	change to I ² C mode	pg. 40	not set
Import	import calibration	pg. 27	n/a
L	enable/disable LED	pg. 21	enabled
M	memory recall/clear	pg. 30	n/a
Name	set/show name of device	pg. 32	not set
Plock	enable/disable protocol lock	pg. 38	disabled
R	returns a single reading	pg. 24	n/a
S	temperature scale (°C, °K, °F)	pg. 28	celsius
Sleep	enter sleep mode/low power	pg. 36	n/a
Status	retrieve status information	pg. 35	n/a
*OK	enable/disable response codes	pg. 34	enable

LED control

Command syntax

L,1 <cr> LED on **default**

L,0 <cr> LED off

L,? <cr> LED state on/off?

Example

Response

L,1 <cr>

*OK <cr>

L,0 <cr>

*OK <cr>

L,? <cr>

?L,1 <cr> or ?L,0 <cr>
*OK <cr>

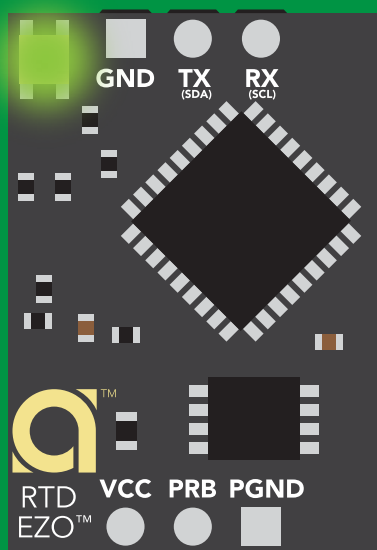

L,1

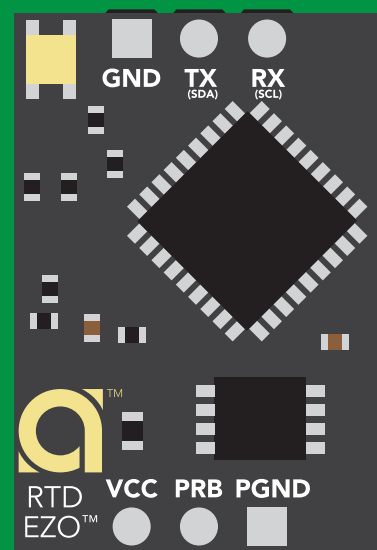

L,0

Find

Command syntax

This command will disable continuous mode
Send any character or command to terminate find.

Find <cr> LED rapidly blinks white, used to help find device

Example

Response

Find <cr>

*OK <cr>

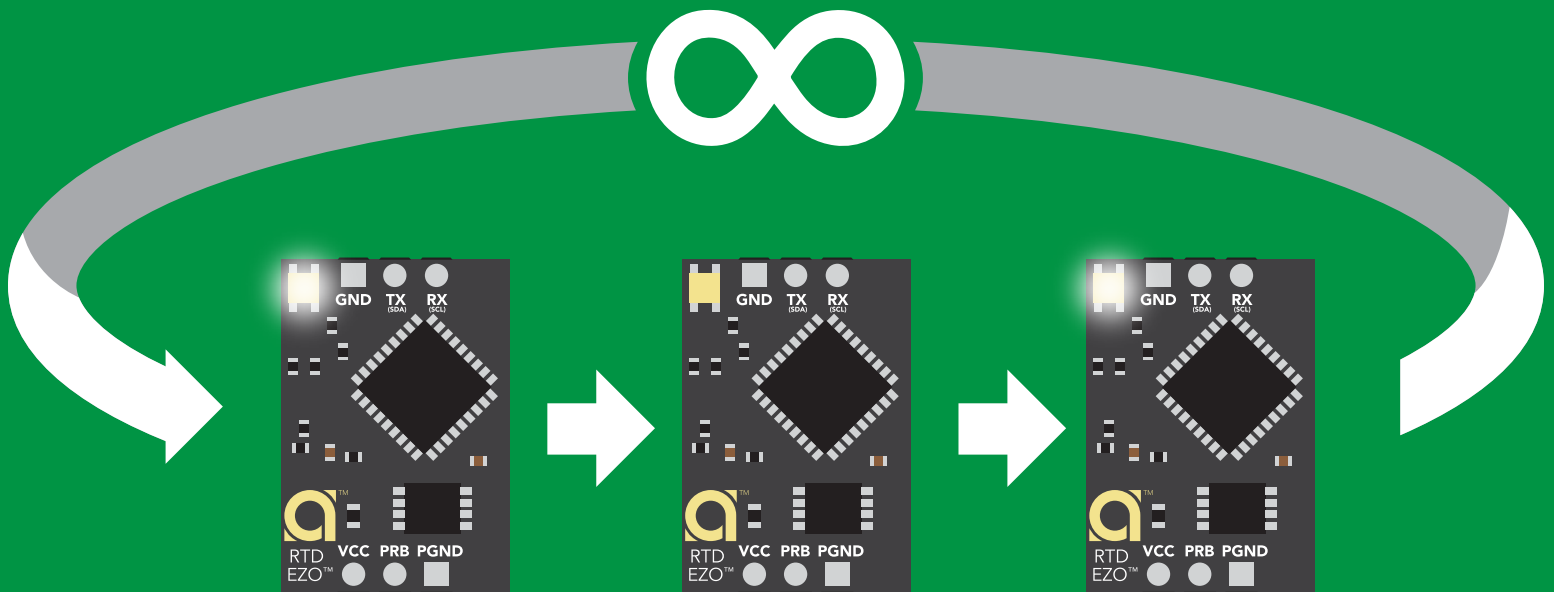

Continuous reading mode

Command syntax

- C,1 <cr>** enable continuous readings once per second **default**
- C,n <cr>** continuous readings every n seconds (n = 2 to 99 sec)
- C,0 <cr>** disable continuous readings
- C,? <cr>** continuous reading mode on/off?

Example

Response

C,1 <cr>

***OK <cr>**
°C (1 sec) <cr>
°C (2 sec) <cr>
°C (n sec) <cr>

C,30 <cr>

***OK <cr>**
°C (30 sec) <cr>
°C (60 sec) <cr>
°C (90 sec) <cr>

C,0 <cr>

***OK <cr>**

C,? <cr>

?C,1 <cr> or ?C,0 <cr> or ?C,30 <cr>
***OK <cr>**

Single reading mode

Command syntax

R <cr> takes single reading

Example

R <cr>

Response

25.104 <cr>
*OK <cr>

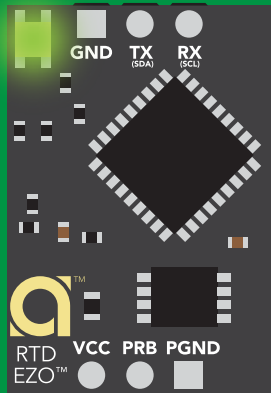

Green
Standby

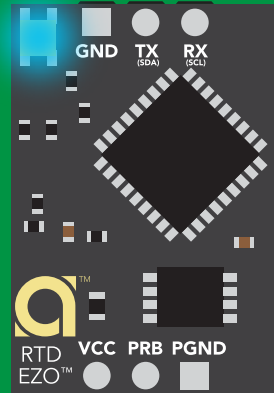

Cyan
Taking reading

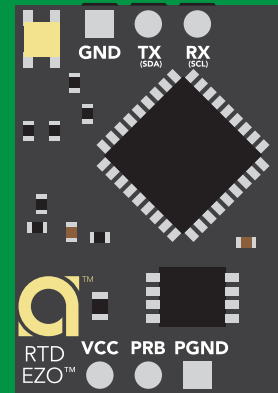

Yellow
Transmitting



600 ms

Calibration

Command syntax

The EZO™ RTD circuit uses single point calibration.

Cal,t <cr> t = any temperature

Cal,clear <cr> delete calibration data

Cal,? <cr> device calibrated?

Example

Response

Cal,100.00 <cr>

***OK** <cr>

Cal,clear <cr>

***OK** <cr>

Cal,? <cr>

?Cal,1 <cr> or **?Cal,0** <cr>

***OK** <cr>

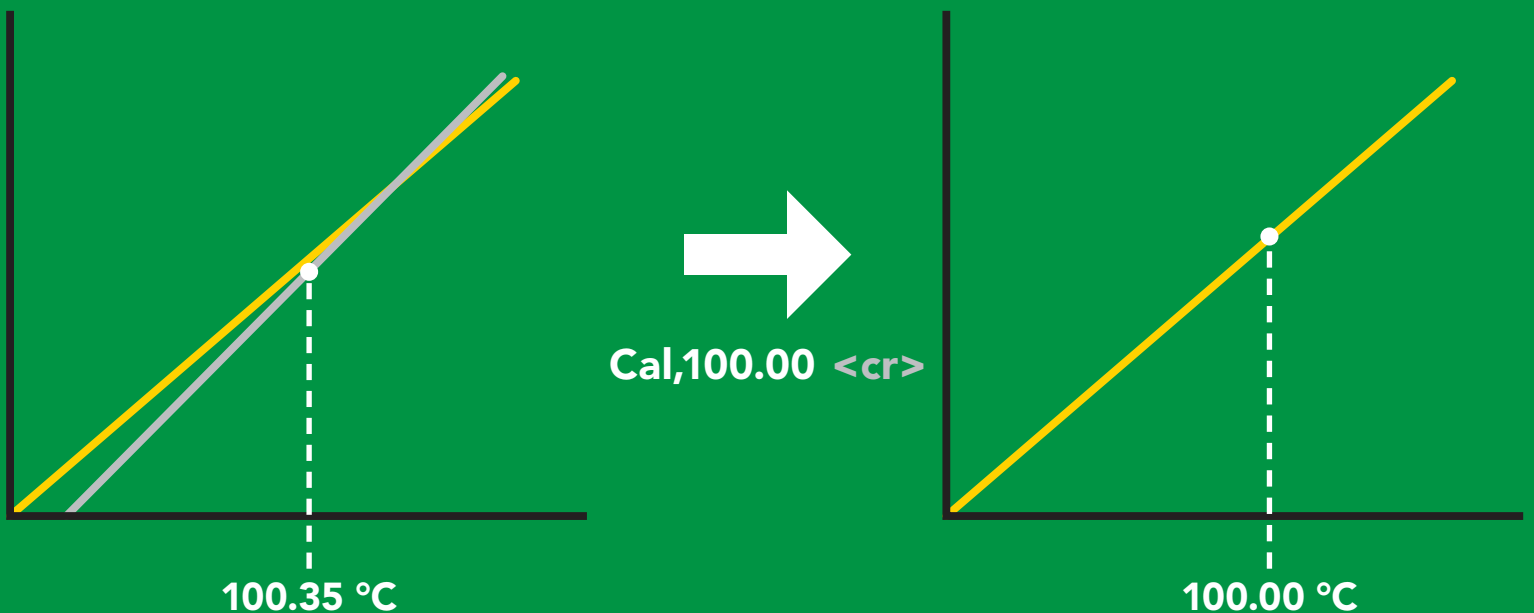

Export calibration

Command syntax

Export: Use this command to download calibration settings

Export,? <cr> calibration string info

Export <cr> export calibration string from calibrated device

Example

Response

Export,? <cr>

10,120 <cr>

Response breakdown

10, 120

of strings to export

of bytes to export

Export strings can be up to 12 characters long, and is always followed by <cr>

Export <cr>

59 6F 75 20 61 72 <cr> (1 of 10)

Export <cr>

65 20 61 20 63 6F <cr> (2 of 10)

(7 more)

⋮

Export <cr>

6F 6C 20 67 75 79 <cr> (10 of 10)

Export <cr>

*DONE

Disabling *OK simplifies this process

Export <cr>

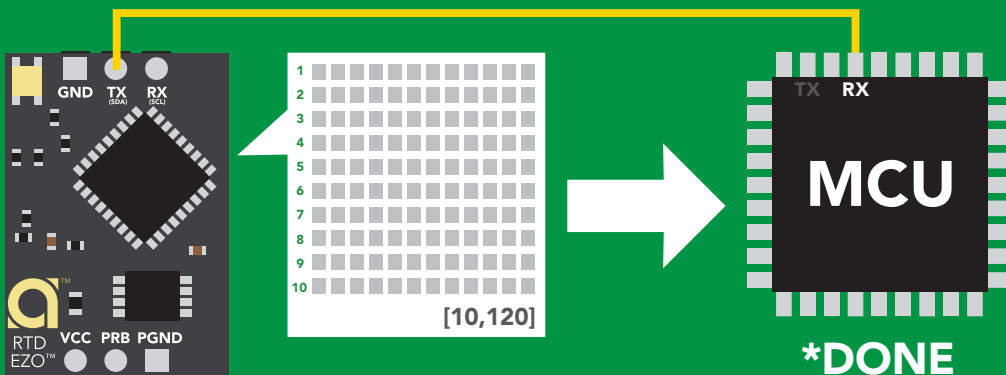

Import calibration

Command syntax

Import: Use this command to upload calibration settings to one or more devices.

Import,n <cr> import calibration string to new device

Example

Import, 59 6F 75 20 61 72 <cr> (1 of 10)

Import, 65 20 61 20 63 6F <cr> (2 of 10)

⋮

Import, 6F 6C 20 67 75 79 <cr> (10 of 10)

Response

*OK <cr>

*OK <cr>

⋮

*OK <cr>

Import,n <cr>

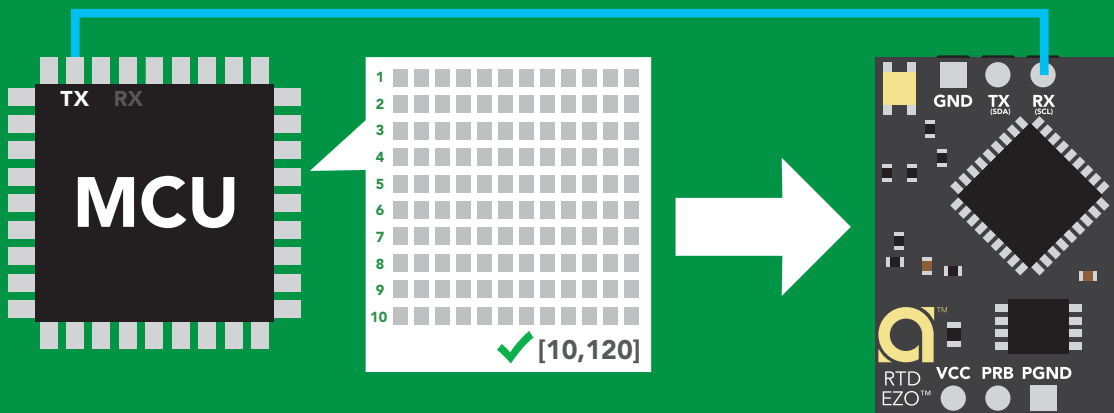

*OK <cr>

system will reboot

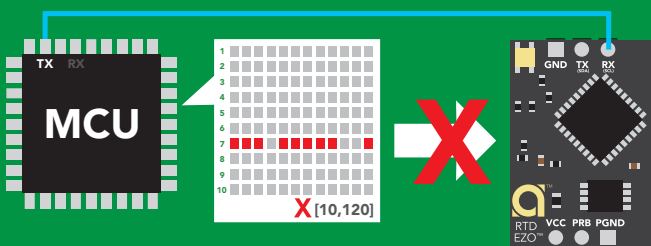

*ER <cr>

* If one of the imported strings is not correctly entered, the device will not accept the import, respond with *ER and reboot.

Temperature scale (°C, °K, °F)

Command syntax

S,c <cr> celsius **default**

S,k <cr> kelvin

S,f <cr> fahrenheit

S,? <cr> temperature scale?

Example

Response

S,c <cr>

*OK <cr>

S,k <cr>

*OK <cr>

S,f <cr>

*OK <cr>

S,? <cr>

?S,c <cr> or ?S,k <cr> or ?S,f <cr>
*OK <cr>

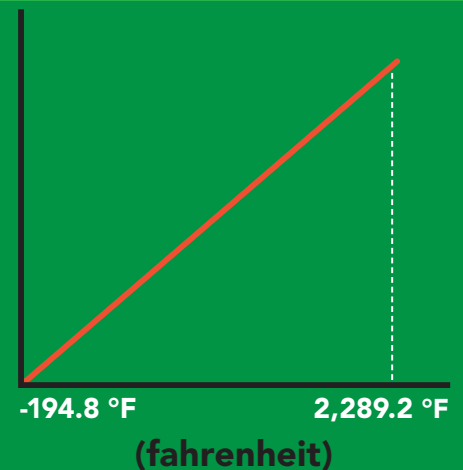
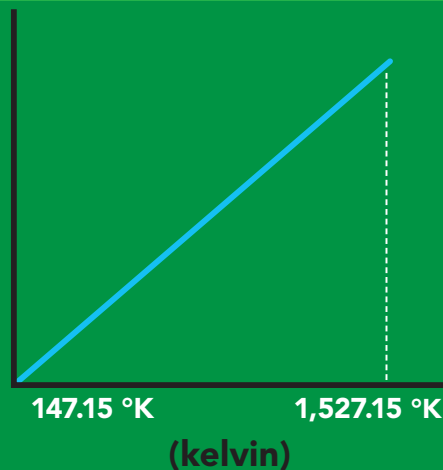
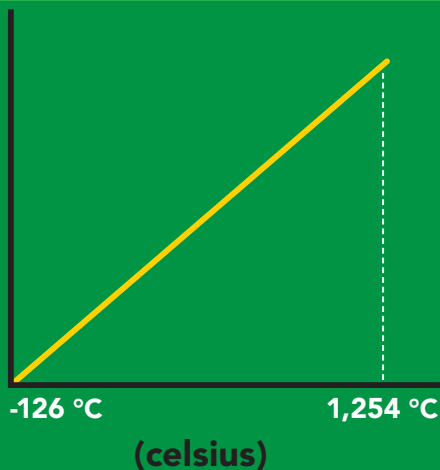

Enable/disable data logger

Command syntax

The time period (n) is in 10 second intervals and can be any value from 1 to 32,000.

D,n <cr> n = (n x 10 seconds)

D,0 <cr> disable **default**

D,? <cr> data logger storage interval?

Example

Response

D,6 <cr>

*OK <cr>

D,0 <cr>

*OK <cr>

D,? <cr>

?D,6 <cr>

*OK <cr>

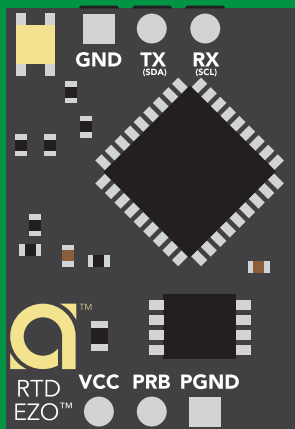

D,6



60 seconds

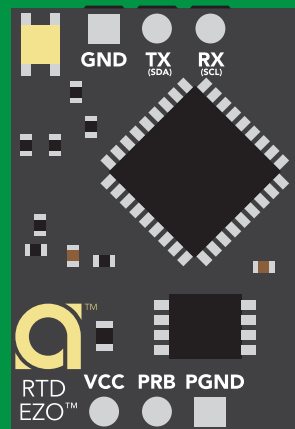

* <cr>

* indicates reading has been logged

Memory recall

Command syntax

Disable data logger to recall memory.

M <cr> recall 1 sequential stored reading

M,all <cr> recall all readings in a CSV string

M,? <cr> display memory location of last stored reading

Example

Response

M <cr>

1,100.00 <cr> 2,104.00 <cr> *OK <cr>

M,all <cr>

100.00,104.00,108.00,112.00 <cr>
Oldest Newest

M,? <cr>

?M,4 <cr>
*OK <cr>

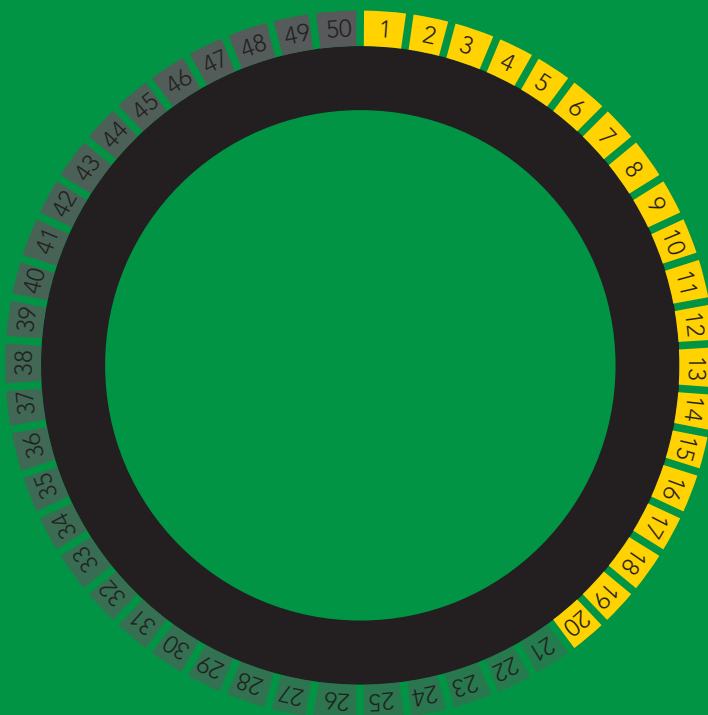

Memory clear

Command syntax

M,clear <cr> clear all stored memory

Example

M,clear <cr>

Response

***OK** <cr>

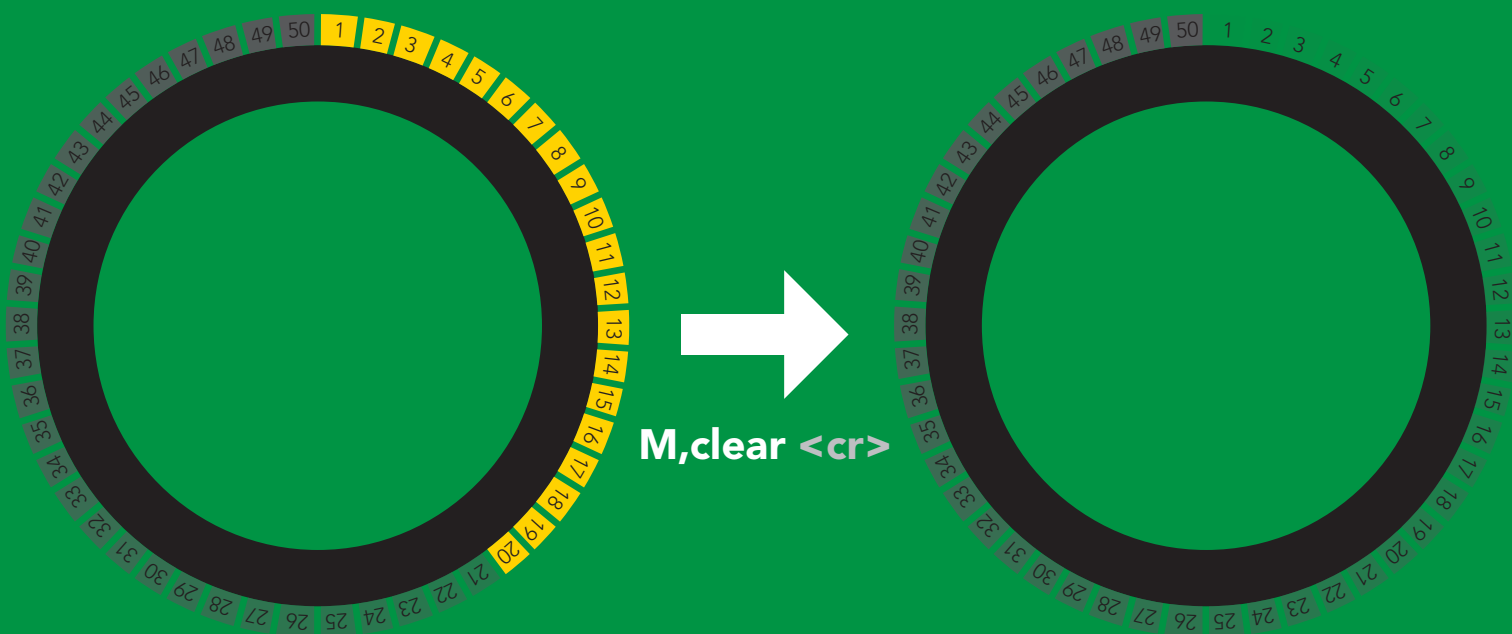

Naming device

Command syntax

Name,n <cr> set name

Name,? <cr> show name

n =

1 2 3 4 5 6 7 8 9 10 11 12 13 14 15 16

Up to 16 ASCII characters

Example

Response

Name,zzt <cr>

*OK <cr>

Name,? <cr>

?Name,zzt <cr>

*OK <cr>

Name,zzt

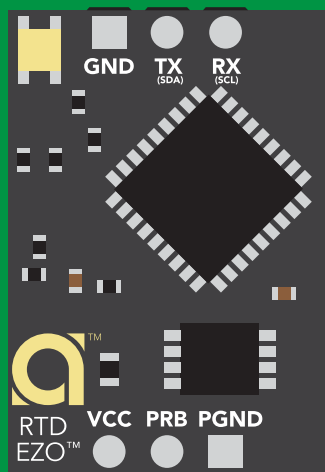

*OK <cr>

Name,?

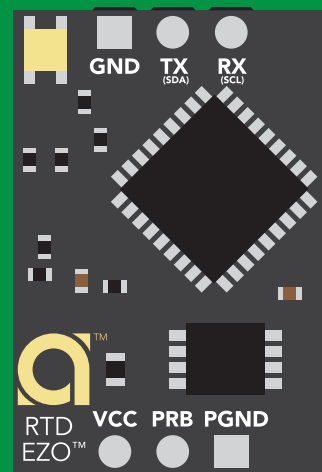

Name,zzt <cr>
*OK <cr>

Device information

Command syntax

```
i <cr> device information
```

Example

```
i <cr>
```

Response

```
?i,RTD,2.01 <cr>  
*OK <cr>
```

Response breakdown

```
?i, RTD, 2.01  
    ↑    ↑  
  Device Firmware
```

Response codes

Command syntax

- *OK,1** <cr> enable response **default**
- *OK,0** <cr> disable response
- *OK,?** <cr> response on/off?

Example

Response

R <cr>

25.104 <cr>
***OK** <cr>

***OK,0** <cr>

no response, ***OK** disabled

R <cr>

25.104 <cr> ***OK** disabled

***OK,?** <cr>

?*OK,1 <cr> or **?*OK,0** <cr>

Other response codes

- *ER** unknown command
- *OV** over volt ($VCC \geq 5.5V$)
- *UV** under volt ($VCC \leq 3.1V$)
- *RS** reset
- *RE** boot up complete, ready
- *SL** entering sleep mode
- *WA** wake up

These response codes
cannot be disabled

Reading device status

Command syntax

Status <cr> voltage at Vcc pin and reason for last restart

Example

```
Status <cr>
```

Response

```
?Status,P,5.038 <cr>  
*OK <cr>
```

Response breakdown

?Status,	P,	5.038
	↑	↑
	Reason for restart	Voltage at Vcc

Restart codes

P	powered off
S	software reset
B	brown out
W	watchdog
U	unknown

Sleep mode/low power

Command syntax

Send any character or command to awaken device.

Sleep <cr> enter sleep mode/low power

Example

Response

Sleep <cr>

*OK <cr>

*SL <cr>

Any command

*WA <cr> wakes up device

5V

STANDBY	SLEEP
15.40 mA	0.4 mA

3.3V

13.80 mA	0.09 mA
----------	---------

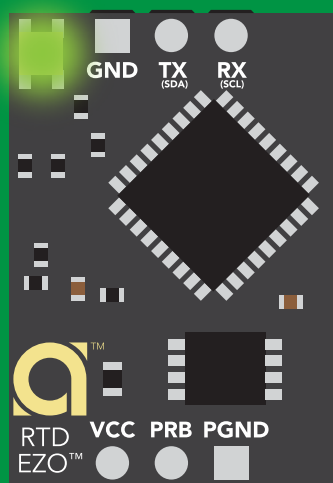

Standby
15.40 mA

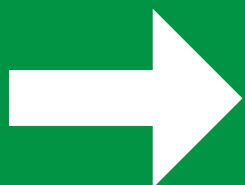

Sleep <cr>

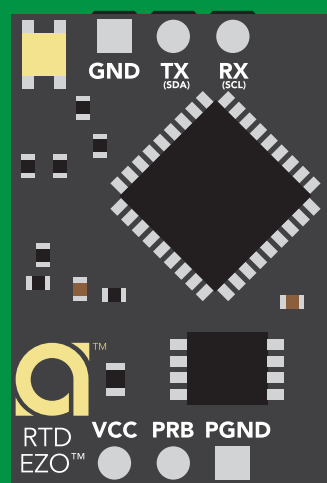

Sleep
3.00 mA

Change baud rate

Command syntax

Baud,n <cr> change baud rate

Example

Baud,38400 <cr>

*OK <cr>

Baud,? <cr>

?Baud,38400 <cr>

*OK <cr>

n =

- 300
- 1200
- 2400
- 9600 default**
- 19200
- 38400
- 57600
- 115200

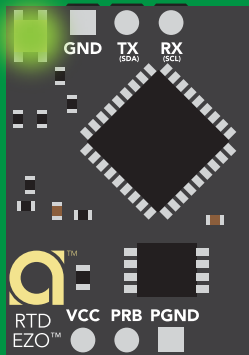

Standby

Baud,38400 <cr>

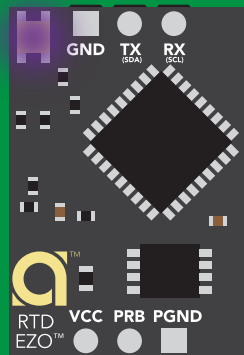

Changing
baud rate

*OK <cr>

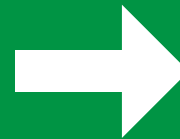

(reboot)

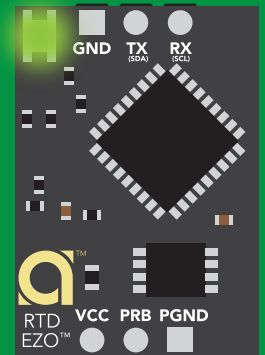

Standby

Protocol lock

Command syntax

Locks device to UART mode.

Plock,1 <cr> enable Plock

Plock,0 <cr> disable Plock **default**

Plock,? <cr> Plock on/off?

Example

Response

Plock,1 <cr>

*OK <cr>

Plock,0 <cr>

*OK <cr>

Plock,? <cr>

?Plock,1 <cr> or ?Plock,0 <cr>

Plock,1

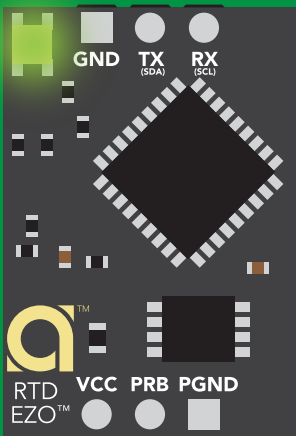

*OK <cr>

I2C,100

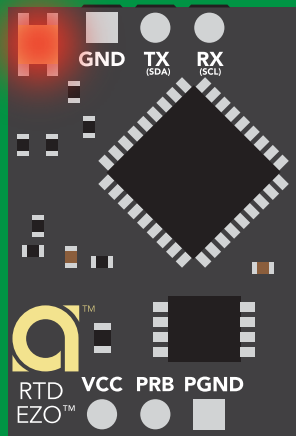

cannot change to I²C

*ER <cr>

Short

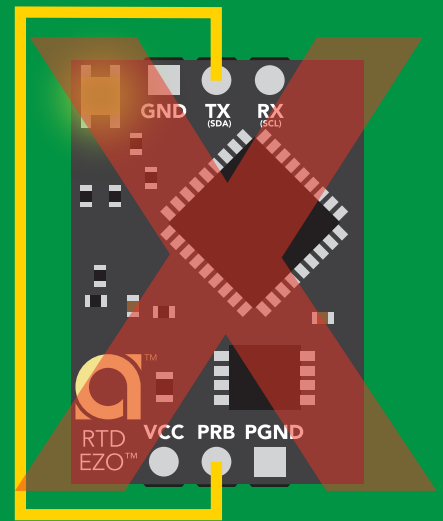

cannot change to I²C

Factory reset

Command syntax

Clears calibration
LED on
"*OK" enabled
Clears data logger

Factory <cr> enable factory reset

Example

Factory <cr>

Response

*OK <cr>

Factory <cr>

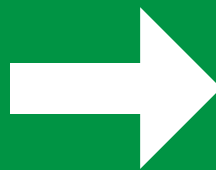
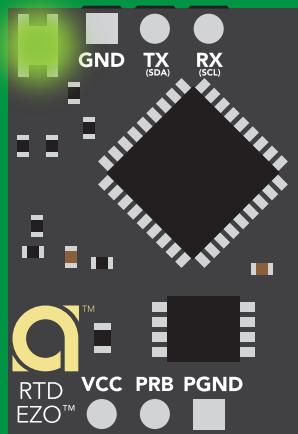

(reboot)

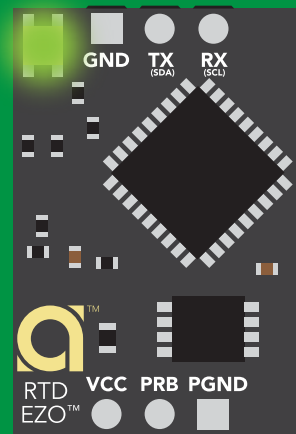

*OK <cr>

*RS <cr>

*RE <cr>

Baud rate will not change

Change to I²C mode

Command syntax

Default I²C address 102 (0x66)

I2C,n <cr> sets I²C address and reboots into I²C mode

n = any number 1 – 127

Example

I2C,100 <cr>

Response

*OK (reboot in I²C mode)

Wrong example

I2C,139 <cr> n ≠ 127

Response

*ER <cr>

I2C,100

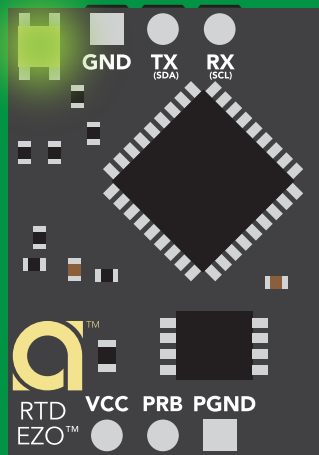

Green
*OK <cr>

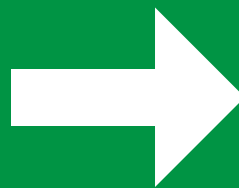

(reboot)

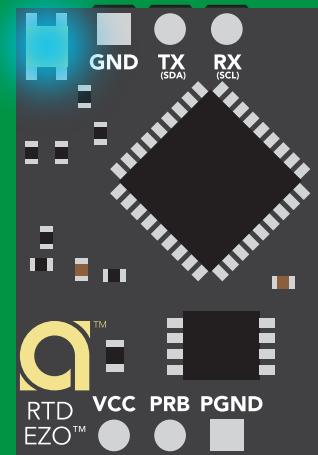

Blue
now in I²C mode

Manual switching to I²C

- Make sure Plock is set to 0
- Disconnect ground (power off)
- Disconnect TX and RX
- Connect TX to PRB
- Confirm RX is disconnected
- Connect ground (power on)
- Wait for LED to change from **Green** to **Blue**
- Disconnect ground (power off)
- Reconnect all data and power

Connecting TX to PRB only works for the EZO-RTD™ and the EZO-FLO™ circuits

Manually switching to I²C will set the I²C address to 102 (0x66)

Example

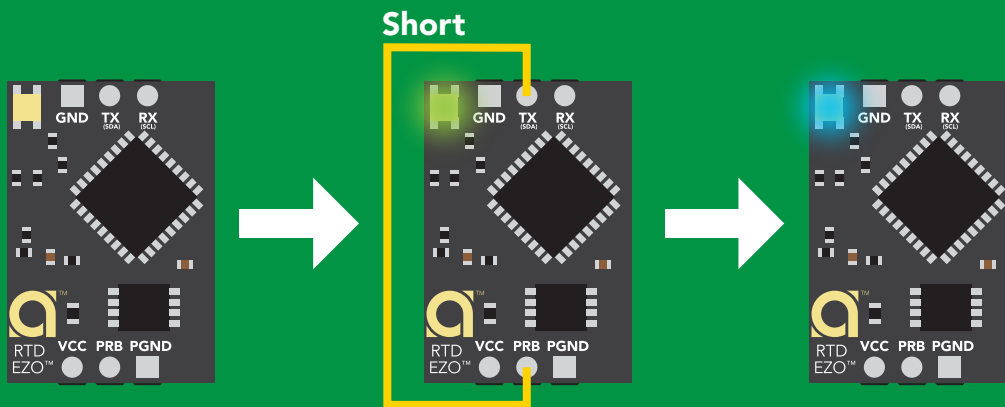

Wrong Example

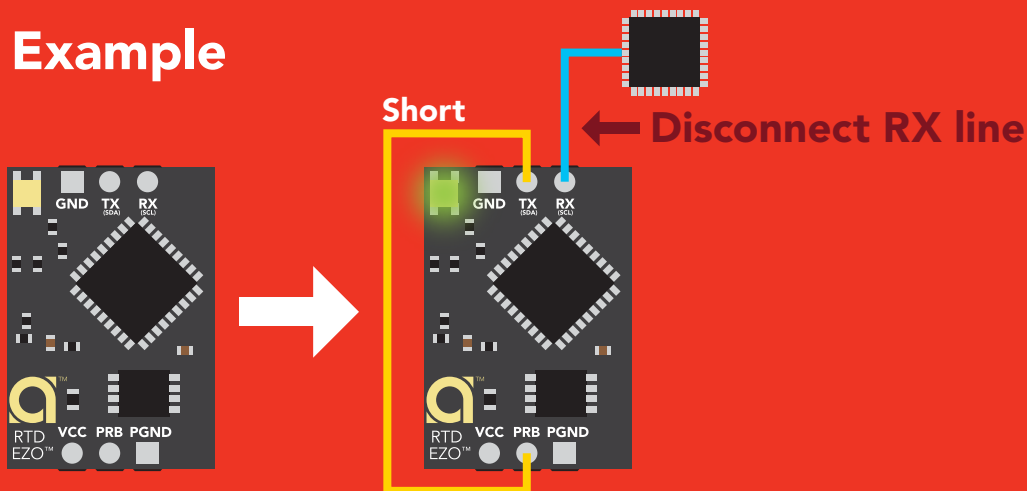

I²C mode

The I²C protocol is **considerably more complex** than the UART (RS-232) protocol. Atlas Scientific assumes the embedded systems engineer understands this protocol.

To set your EZO™ device into I²C mode click [here](#)

Settings that are retained if power is cut

- Calibration
- Change I²C address
- Hardware switch to UART mode
- LED control
- Protocol lock
- Software switch to UART mode

Settings that are **NOT** retained if power is cut

- Find
- Sleep mode

I²C mode

I²C address (0x01 – 0x7F)
102 (0x66) default

Vcc 3.3V – 5.5V

Clock speed 100 – 400 kHz

SDA 

SCL 

0V VCC 0V

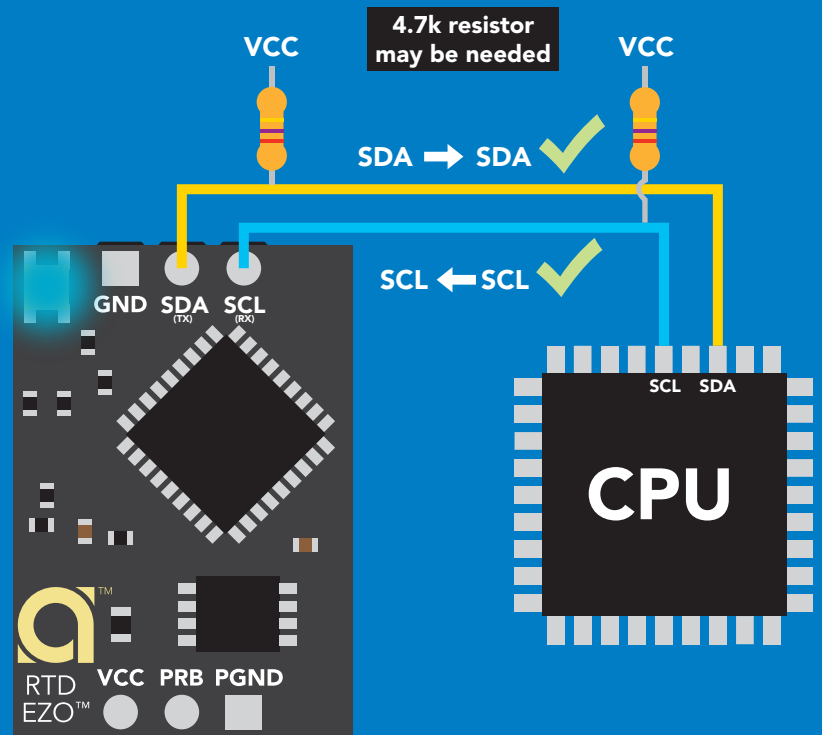

Data format

Reading temperature

Units °C, °K, or °F

Encoding ASCII

Format string

Data type floating point

Decimal places 3

Smallest string 4 characters

Largest string 40 characters

Sending commands to device

5 parts



Example

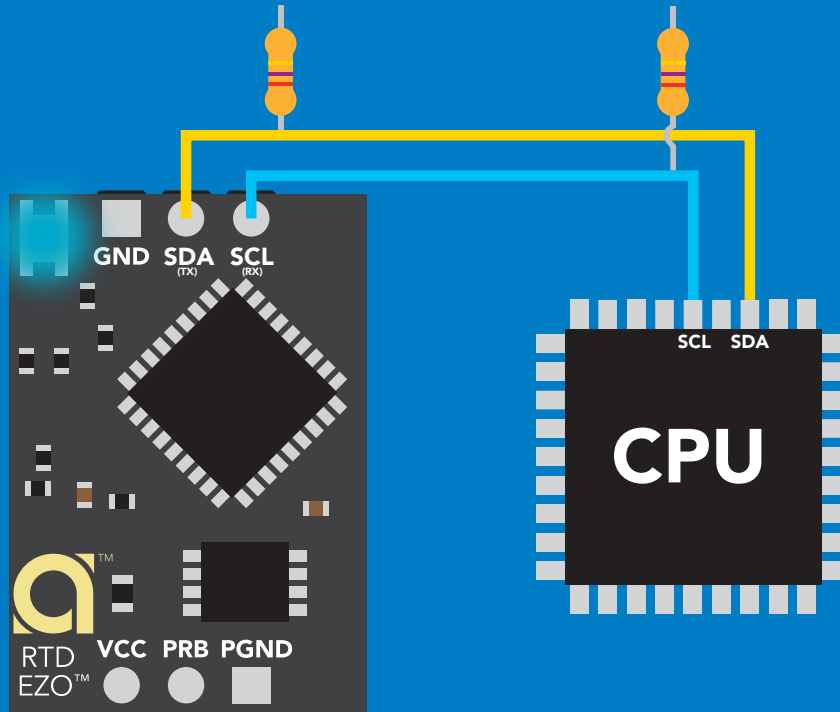

Advanced

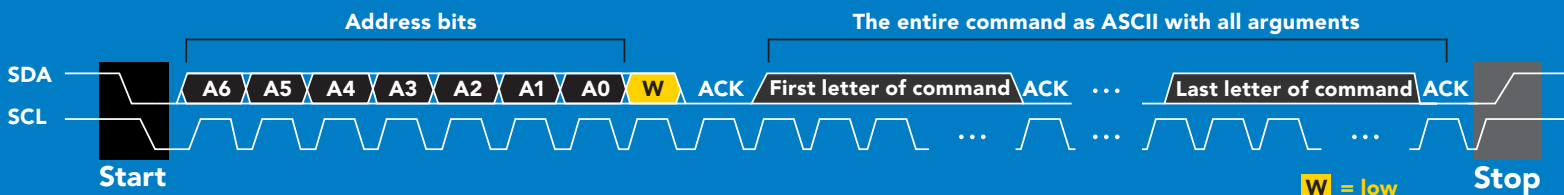

Requesting data from device

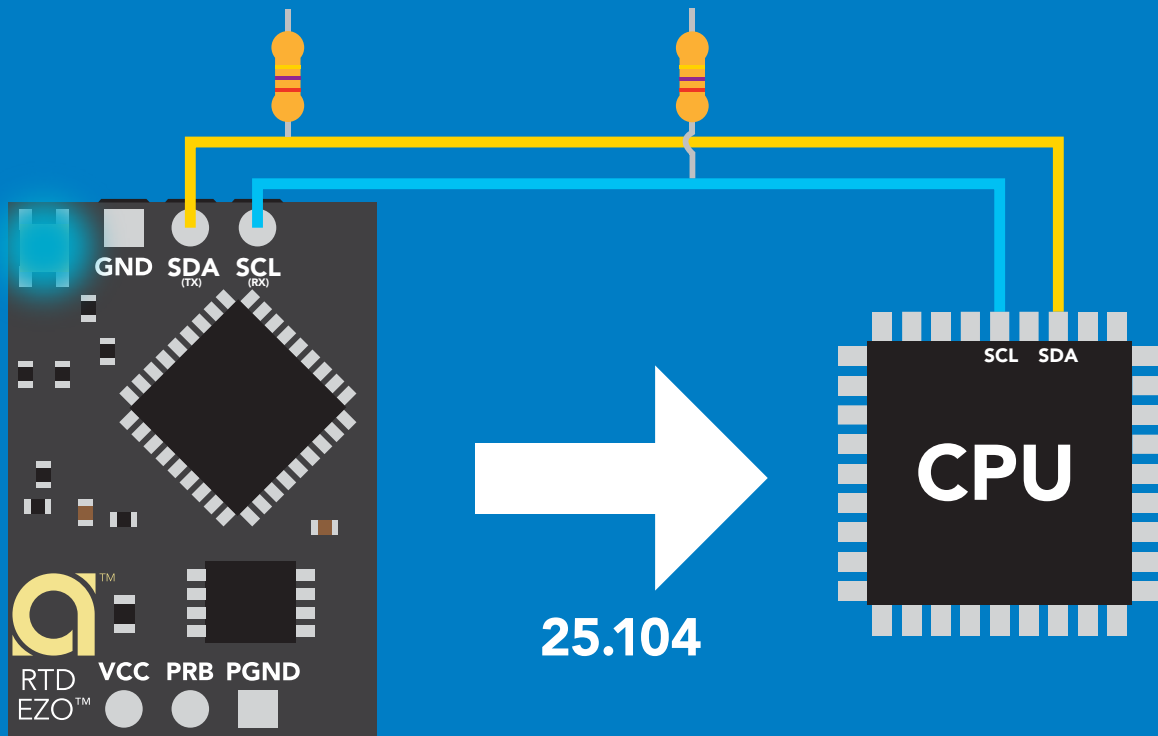
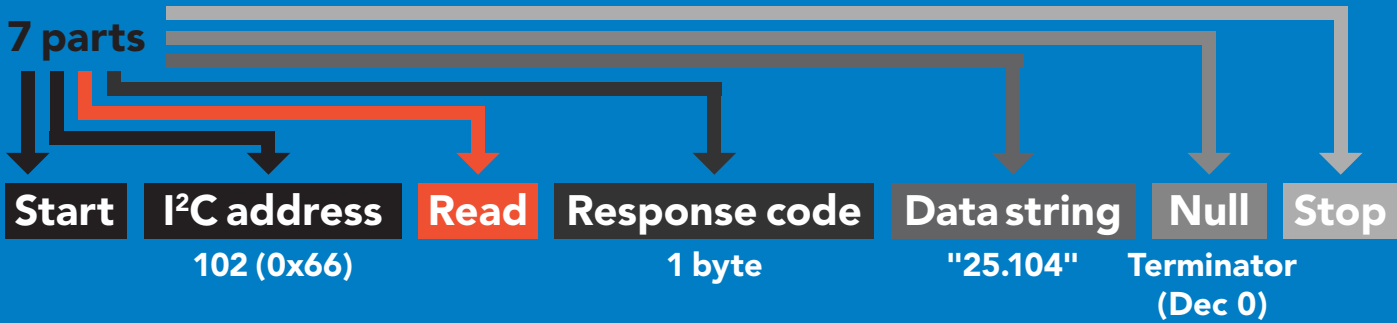

Advanced

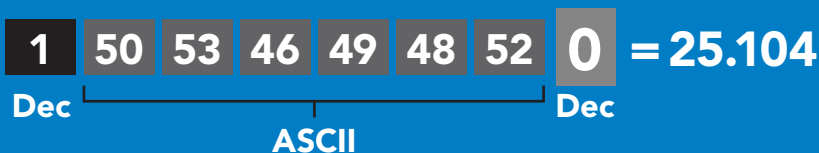
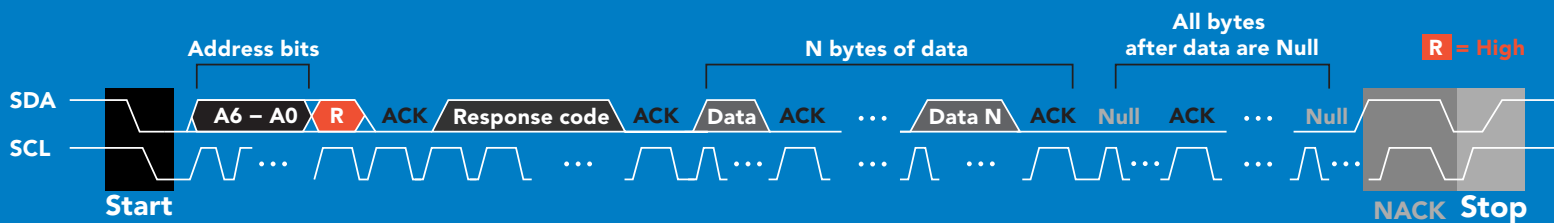

Response codes

After a command has been issued, a 1 byte response code can be read in order to confirm that the command was processed successfully.

Reading back the response code is completely optional, and is not required for normal operation.

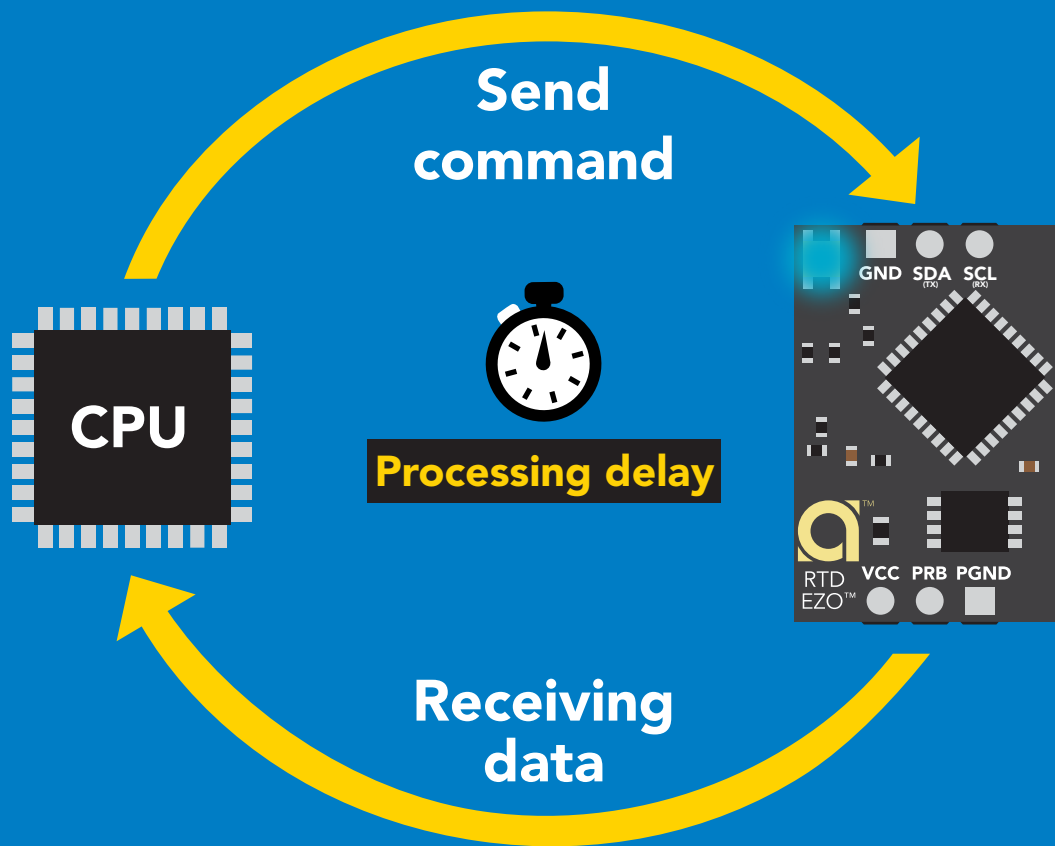

Example

```
I2C_start;  
I2C_address;  
I2C_write(EZO_command);  
I2C_stop;
```

`delay(300);`



Processing delay

```
I2C_start;  
I2C_address;  
Char[ ] = I2C_read;  
I2C_stop;
```

If there is no processing delay or the processing delay is too short, the response code will always be 254.

Response codes

Single byte, not string

255	no data to send
254	still processing, not ready
2	syntax error
1	successful request

LED color definition

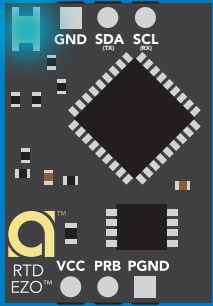

Blue

I²C standby

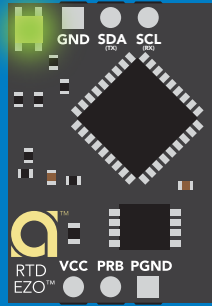

Green

Taking reading

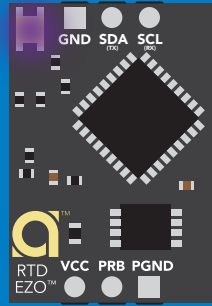

Purple

Changing
I²C address

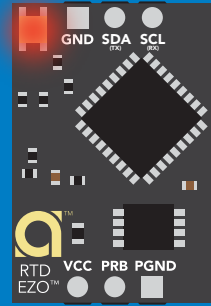

Red

Command
not understood

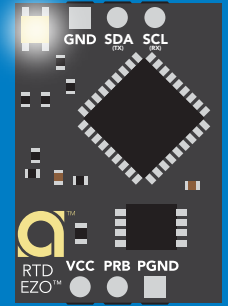

White

Find

5V

LED ON

+0.4 mA

3.3V

+0.2 mA

I²C mode

command quick reference

All commands are ASCII strings or single ASCII characters.

Command	Function	
Baud	switch back to UART mode	pg. 65
Cal	performs calibration	pg. 52
D	enable/disable data logger	pg. 56
Export	export calibration	pg. 53
Factory	enable factory reset	pg. 64
Find	finds devices with white blinking LED	pg. 50
i	device information	pg. 59
I2C	change I ² C address	pg. 63
Import	import calibration	pg. 54
L	enable/disable LED	pg. 49
M	memory recall/clear	pg. 57
Plock	enable/disable protocol lock	pg. 62
R	returns a single reading	pg. 51
S	temperature scale (°C, °K, °F)	pg. 55
Sleep	enter sleep mode/low power	pg. 61
Status	retrieve status information	pg. 60

LED control

Command syntax

300ms  processing delay

- L,1 LED on **default**
- L,0 LED off
- L,? LED state on/off?

Example

Response

L,1

 **Wait 300ms** **1** **0**
Dec Null

L,0

 **Wait 300ms** **1** **0**
Dec Null

L,?

 **Wait 300ms** **1** **?L,1** **0** or **1** **?L,0** **0**
Dec ASCII Null Dec ASCII Null

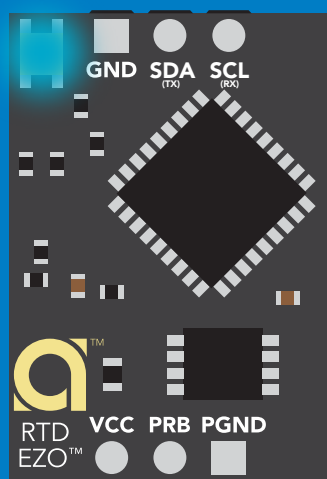

L,1

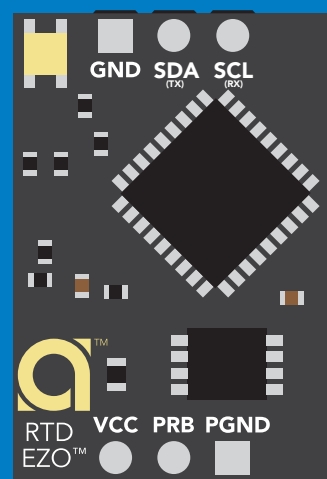

L,0

Find

300ms  processing delay

Command syntax

This command will disable continuous mode
Send any character or command to terminate find.

Find LED rapidly blinks white, used to help find device

Example

Response

Find <cr>

 Wait 300ms
1 Dec 0 Null

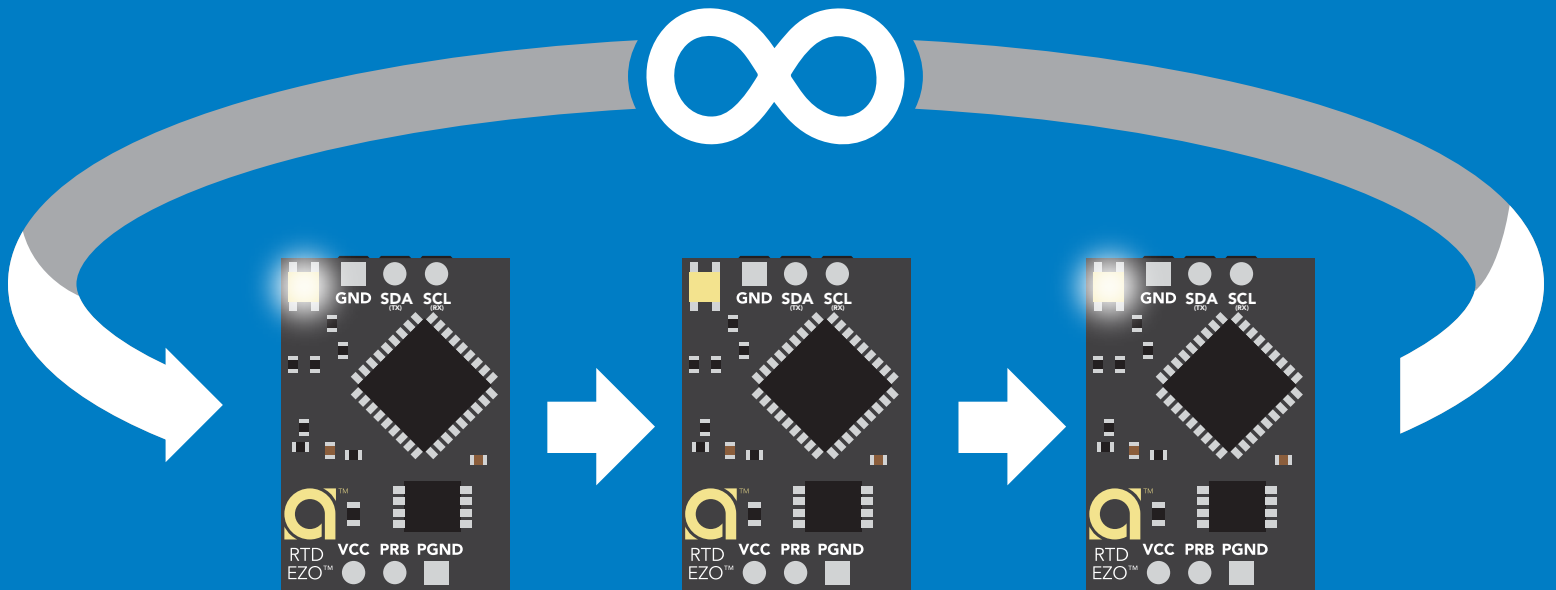

Taking reading

Command syntax

600ms  processing delay

R return 1 reading

Example

Response

R

 **Wait 600ms** **1** **25.104** **0**
Dec ASCII Null

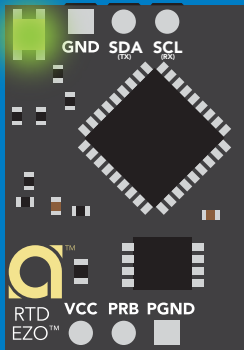

Green

Taking reading

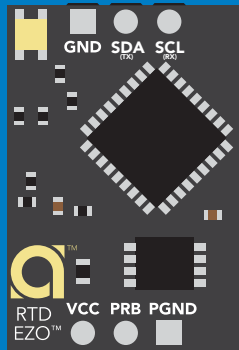
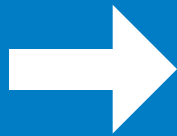

Transmitting

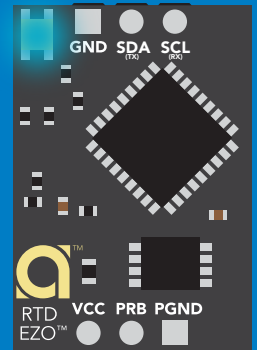
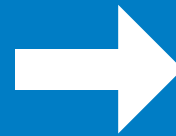

Blue

Standby

Calibration

Command syntax

600ms  processing delay

- Cal,t t = any temperature
- Cal,clear delete calibration data
- Cal,? device calibrated?

EZO™ RTD circuit uses single point calibration.

Example

Response

Cal,t

 Wait 600ms **1** **0**
Dec Null

Cal,clear

 Wait 300ms **1** **0**
Dec Null

Cal,?

 Wait 300ms **1** **?Cal,1** **0** or **1** **?Cal,0** **0**
Dec ASCII Null Dec ASCII Null

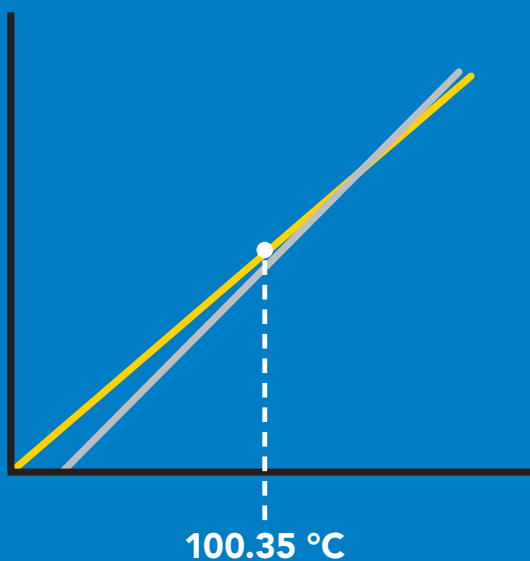

→
Cal,100.00

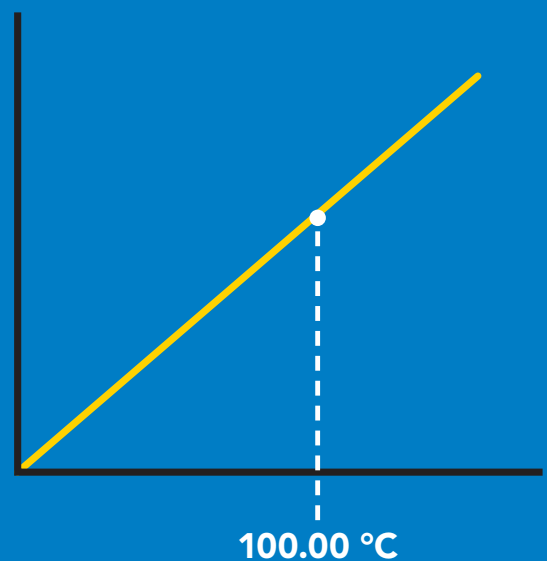

Export calibration

300ms  processing delay

Command syntax

Export: Use this command to download calibration settings

Export,? calibration string info

Export export calibration string from calibrated device

Example

Response

Export,?



Wait 300ms

1

Dec

10,120

ASCII

0

Null

Response breakdown

10, 120

of strings to export # of bytes to export

Export strings can be up to 12 characters long

Export



Wait 300ms

1

Dec

59 6F 75 20 61 72

ASCII

0

Null

(1 of 10)

Export



Wait 300ms

1

Dec

65 20 61 20 63 6F

ASCII

0

Null

(2 of 10)

(7 more)

⋮

Export



Wait 300ms

1

Dec

6F 6C 20 67 75 79

ASCII

0

Null

(10 of 10)

Export



Wait 300ms

1

Dec

*DONE

ASCII

0

Null

Import calibration

300ms  processing delay

Command syntax

Import: Use this command to upload calibration settings to one or more devices.

Import,n import calibration string to new device

Example

Import, 59 6F 75 20 61 72 (1 of 10)

Import, 65 20 61 20 63 6F (2 of 10)

⋮

Import, 6F 6C 20 67 75 79 (10 of 10)

Response

 **1** **0**
Wait 300ms Dec Null

 **1** **0**
Wait 300ms Dec Null

⋮

 **1** **0**
Wait 300ms Dec Null

Import,n

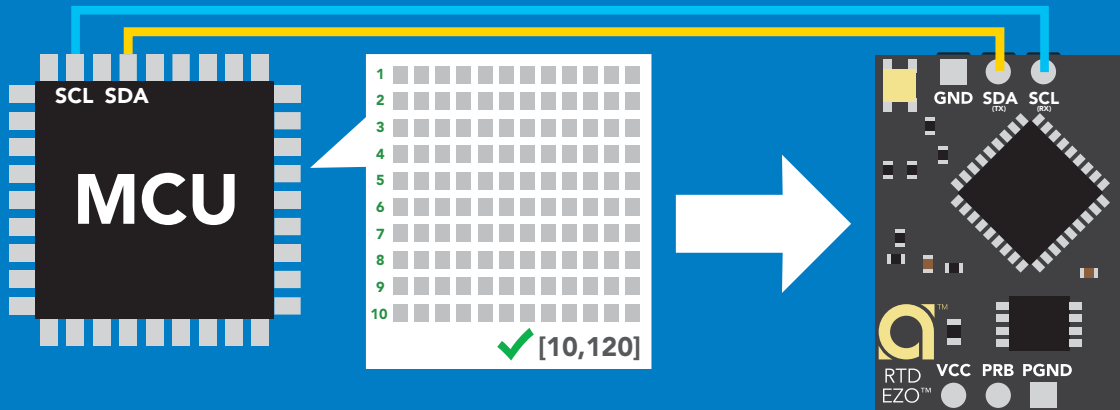

1 ***Pending** **0**
Dec ASCII Null

system will reboot

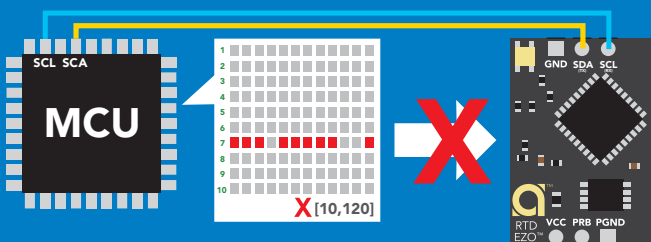

reboot

* If one of the imported strings is not correctly entered, the device will not accept the import and reboot.

Temperature scale (°C, °K, °F)

Command syntax

300ms  processing delay

- S,c celsius **default**
- S,k kelvin
- S,f fahrenheit
- S,? temperature scale?

Example

Response

S,c

 **Wait 300ms** **1** **0**
Dec Null

S,k

 **Wait 300ms** **1** **0**
Dec Null

S,f

 **Wait 300ms** **1** **0**
Dec Null

S,?

 **Wait 300ms** **1** **?S,f** **0** or **1** **?S,k** **0** or **1** **?S,k** **0**
Dec ASCII Null Dec ASCII Null Dec ASCII Null

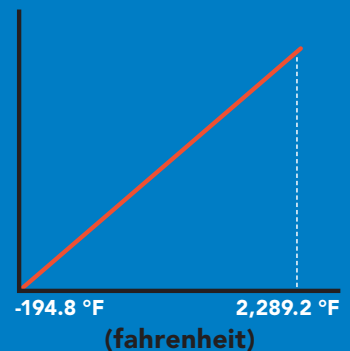
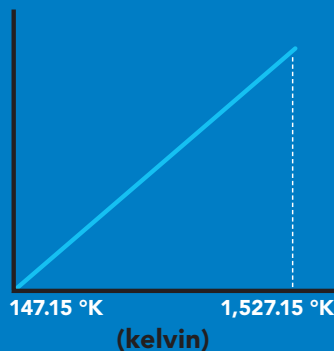
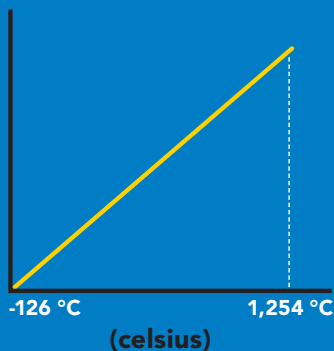

Enable/disable data logger

Command syntax

300ms  processing delay

D,n n = (n x 10 seconds)

D,0 disable

D,? data logger storage interval?

The time period (n) is in 10 second intervals and can be any value from 1 to 32,000.

Example

Response

D,6

Wait 300ms

1	0
Dec	Null

D,0



Wait 300ms

1	0
Dec	Null

D,?

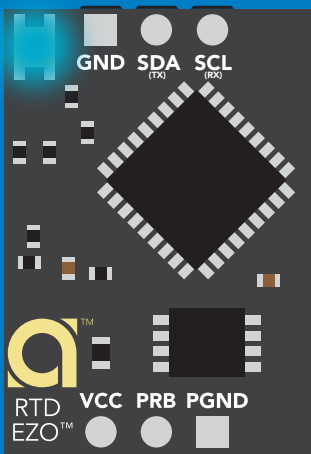

Wait 300ms

1	?D,6	0
Dec	ASCII	Null

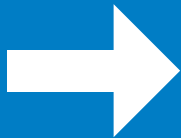

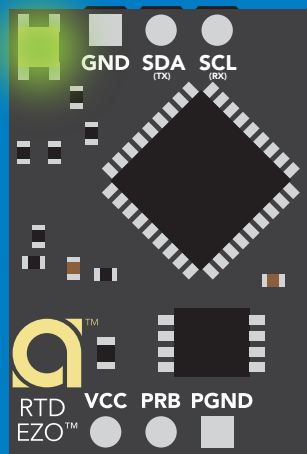
D,6
(after 60 seconds)

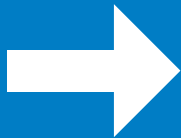



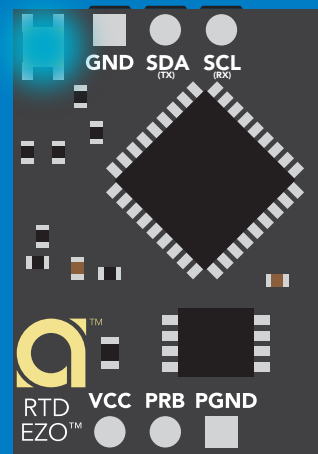

Memory recall

Disable data logger to recall memory.

Command syntax

300ms  processing delay

M recall 1 sequential stored reading

M,? display memory location of last stored reading

Example

Response

M		1	1,100.00	0
	Wait 300ms	Dec	ASCII	Null

M,?		1	4,112.00	0
	Wait 300ms	Dec	ASCII	Null

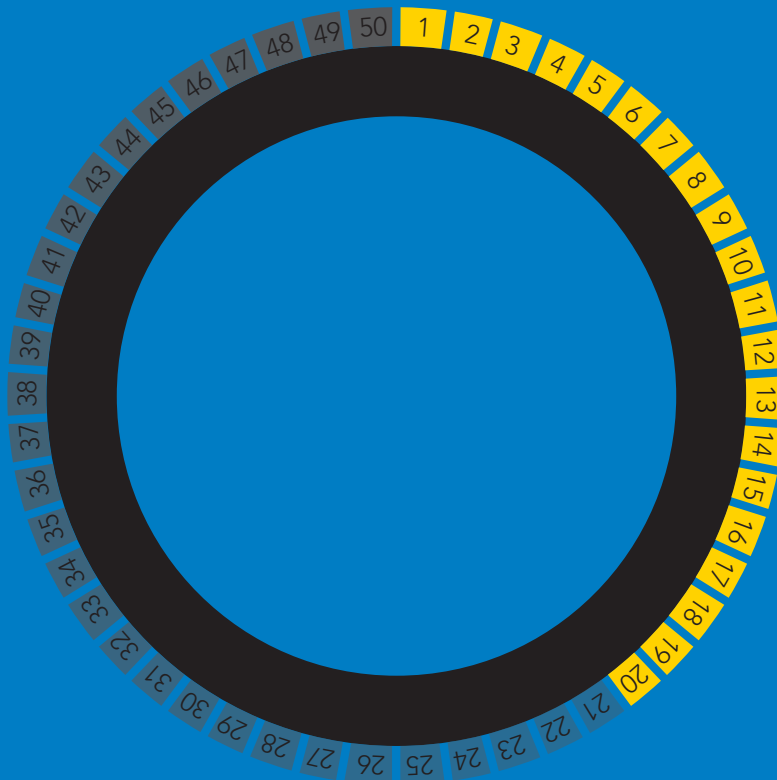

Memory clear

Command syntax

300ms  processing delay

M,clear clear all stored memory

Example

Response

M,clear



Wait 300ms

1

Dec

0

Null

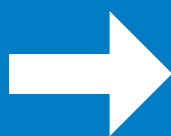
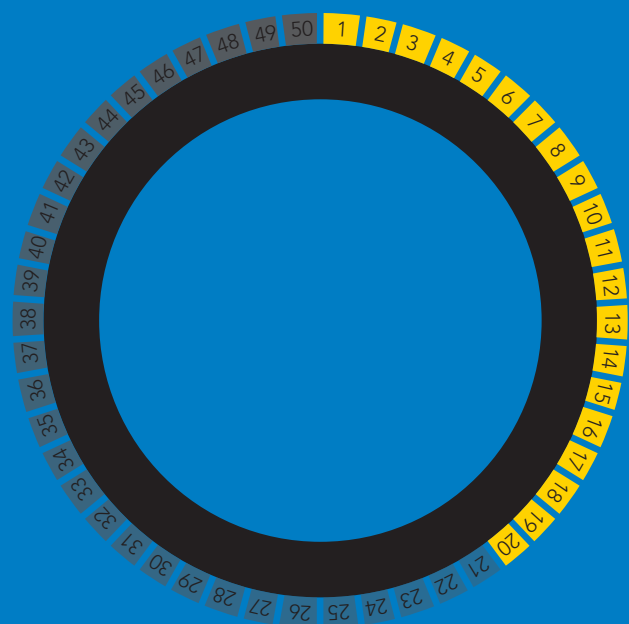

M,clear

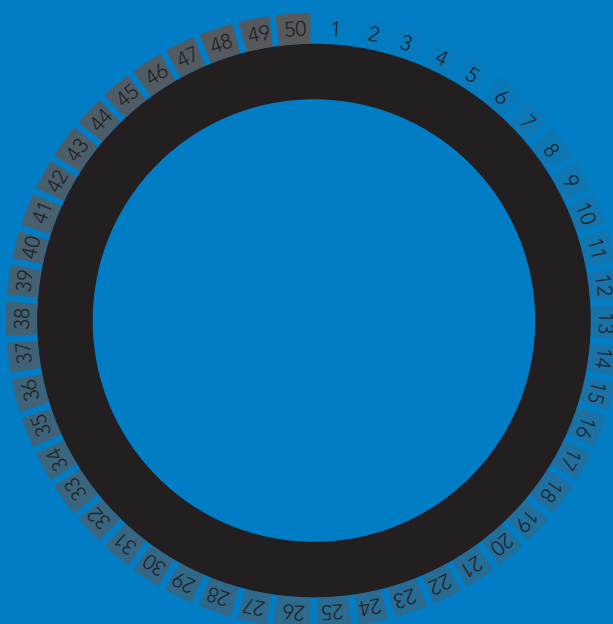

Device information

Command syntax

300ms  processing delay

i device information

Example

Response

i



Wait 300ms

1

Dec

?i,RTD,2.01

ASCII

0

Null

Response breakdown

?i, RTD, 2.01
↑ ↑
Device Firmware

Reading device status

Command syntax

300ms  processing delay

Status voltage at Vcc pin and reason for last restart

Example

Response

Status

 **1** **?Status,P,5.038** **0**
Wait 300ms Dec ASCII Null

Response breakdown

?Status, **P,** **5.038**
Reason for restart Voltage at Vcc

Restart codes

P powered off
S software reset
B brown out
W watchdog
U unknown

Sleep mode/low power

Command syntax

Sleep enter sleep mode/low power

Send any character or command to awaken device.

Example

Response

Sleep

no response

Do not read status byte after issuing sleep command.

Any command

wakes up device

5V

STANDBY	SLEEP
15.40 mA	0.4 mA

3.3V

13.80 mA	0.09 mA
----------	---------

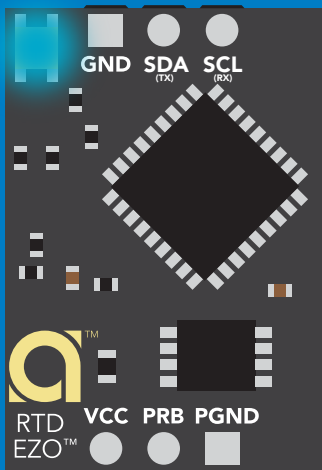

Standby

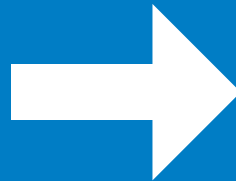

Sleep

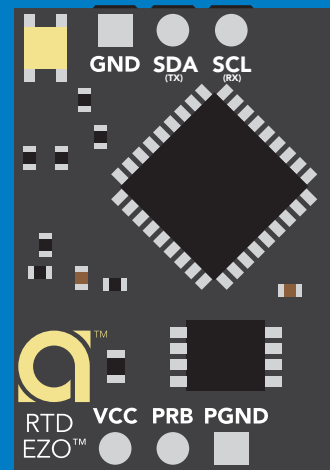

Sleep

Protocol lock

Command syntax

300ms  processing delay

Plock,1 enable Plock

Plock,0 disable Plock

Plock,? Plock on/off?

default

Locks device to I²C mode.

Example

Response

Plock,1

Wait 300ms

1	0
Dec	Null

Plock,0

Wait 300ms

1	0
Dec	Null

Plock,?

Wait 300ms

1	?Plock,1	0
Dec	ASCII	Null

Plock,1

Baud, 9600

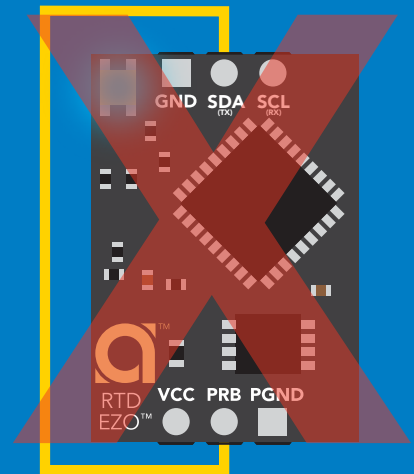
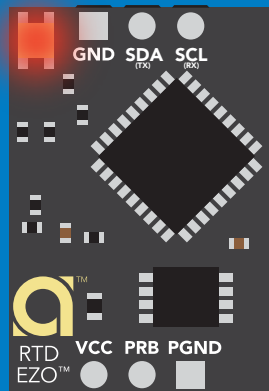
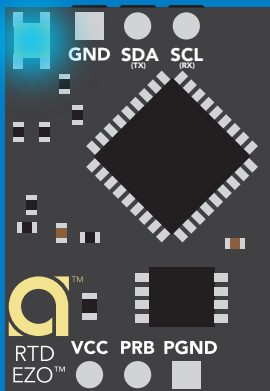

cannot change to UART

cannot change to UART

I²C address change

Command syntax

300ms  processing delay

I2C,n sets I²C address and reboots into I²C mode

Example

Response

I2C,100

device reboot

Warning!

Changing the I²C address will prevent communication between the circuit and the CPU until the CPU is updated with the new I²C address.

Default I²C address is 102 (0x66).

n = any number 1 – 127

I2C,100

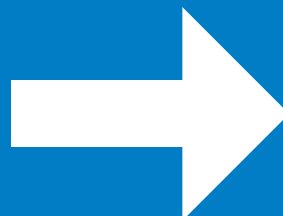
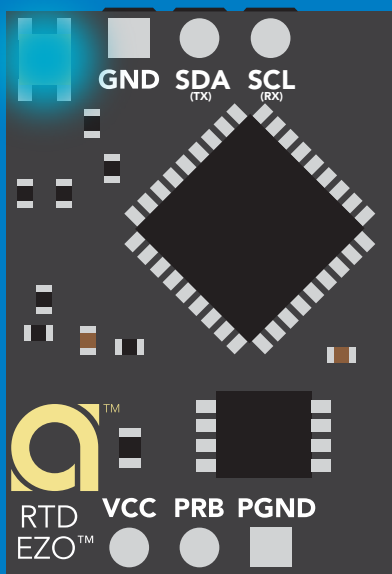

(reboot)

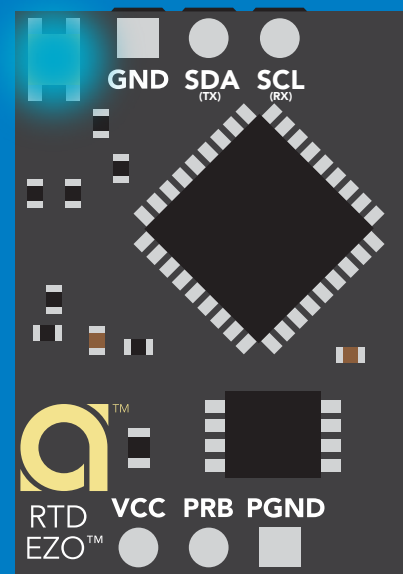

Factory reset

Command syntax

Factory reset will not take the device out of I²C mode.

Factory enable factory reset

I²C address will not change

Example

Response

Factory

device reboot

Clears calibration
LED on
Response codes enabled
Clears data logger

Factory

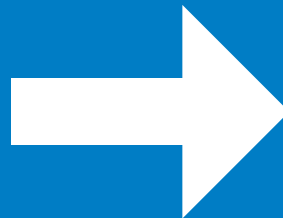
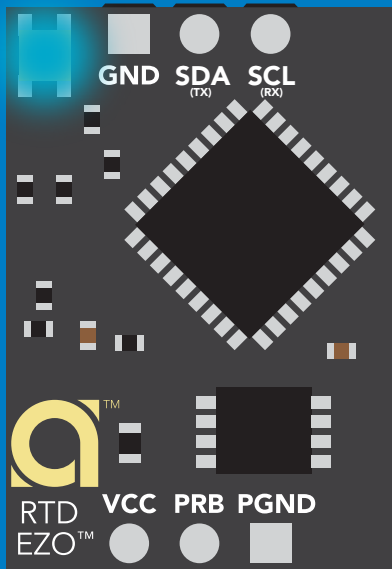

(reboot)

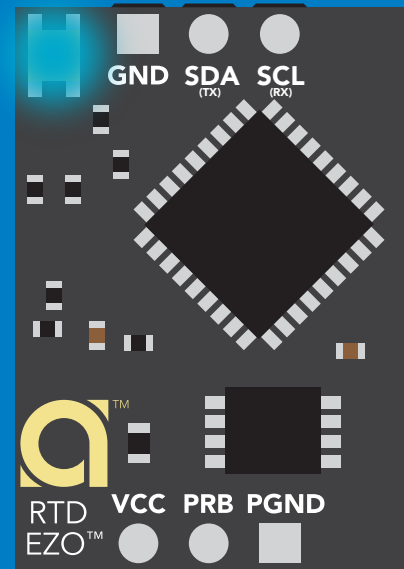

Change to UART mode

Command syntax

Baud,n switch from I²C to UART

Example

Baud,9600

Response

reboot in UART mode

n = [300
1200
2400
9600
19200
38400
57600
115200

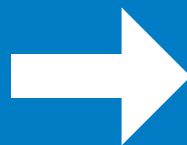
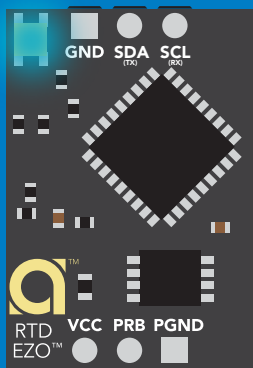

Baud,9600

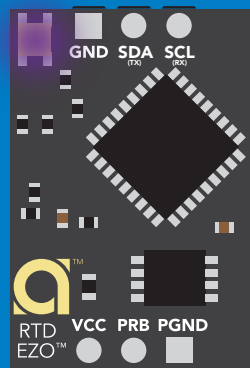

Changing to
UART mode



(reboot)

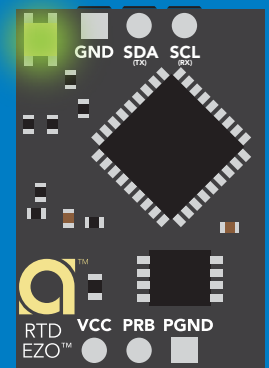

Manual switching to UART

- Make sure Plock is set to 0
- Disconnect ground (power off)
- Disconnect TX and RX
- Connect TX to PRB
- Confirm RX is disconnected
- Connect ground (power on)
- Wait for LED to change from Blue to Green
- Disconnect ground (power off)
- Reconnect all data and power

Connecting TX to PRB only works for the EZO-RTD™ and the EZO-FLO™ circuits

Example

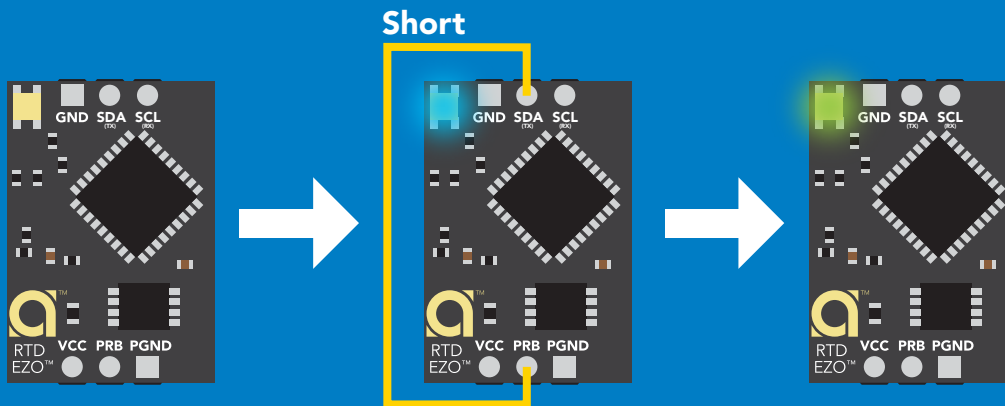

Wrong Example

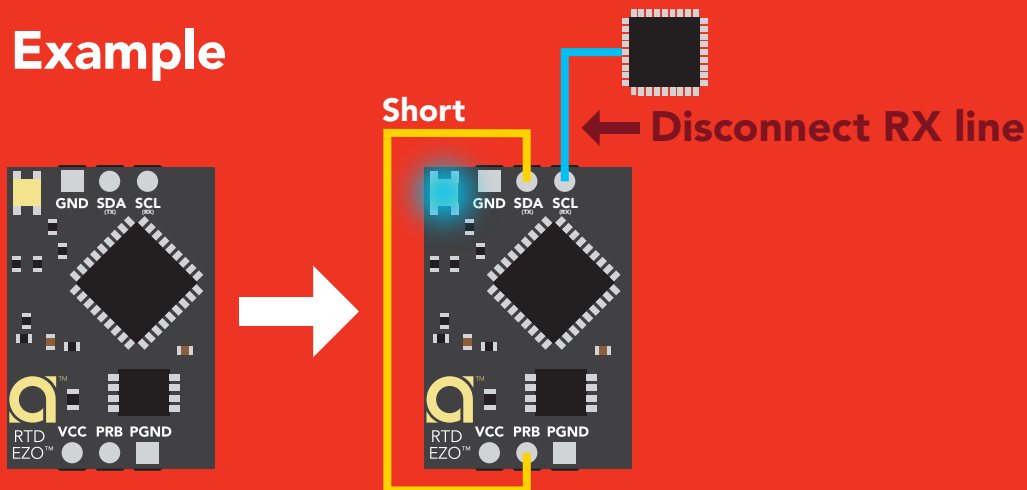

EZO™ circuit footprint

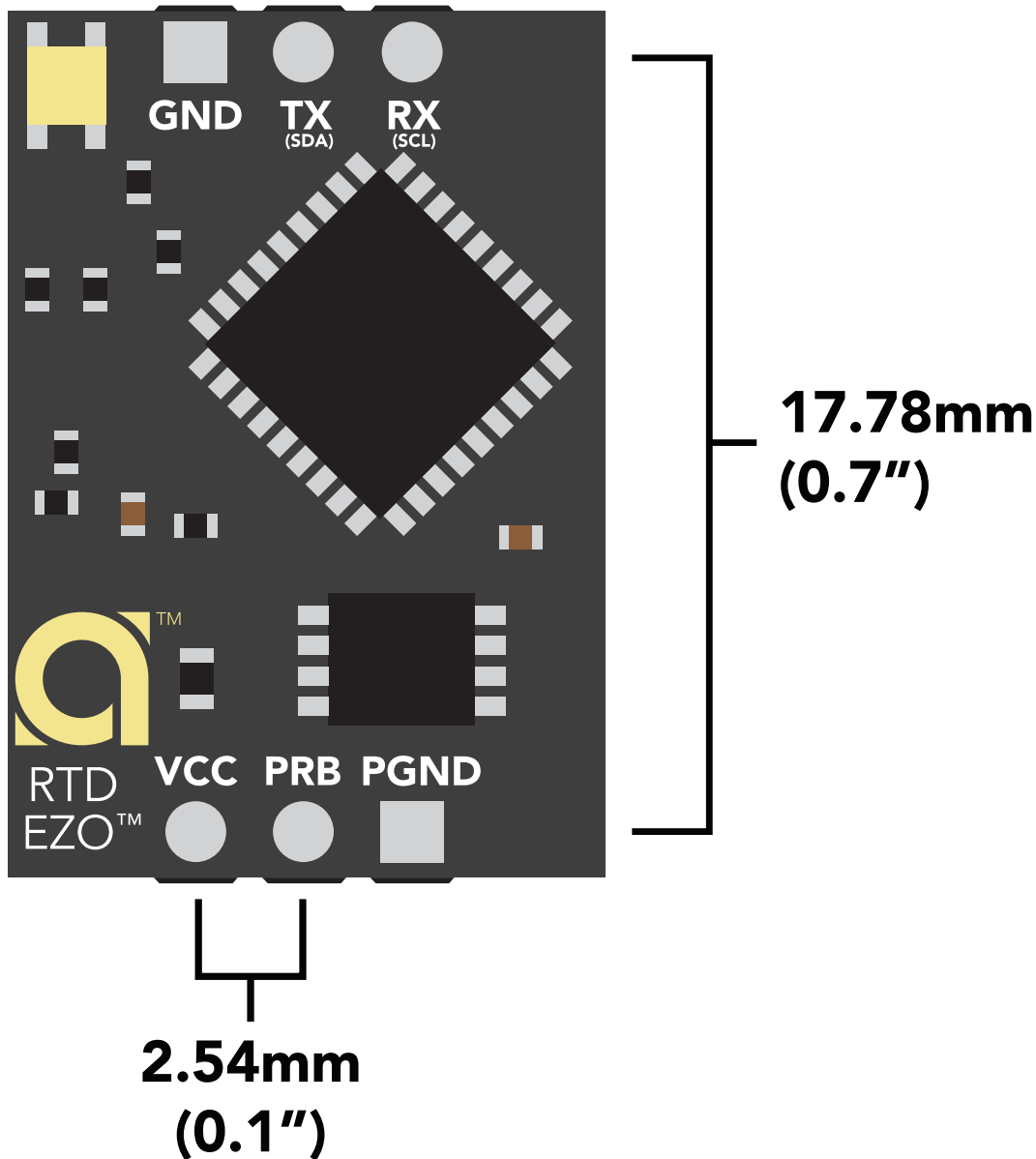

1 In your CAD software place a 8 position header.

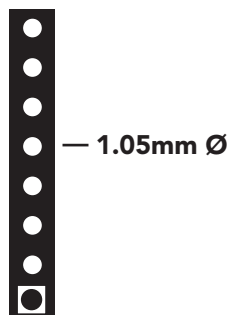

2 Place a 3 position header at both top and bottom of the 8 position.

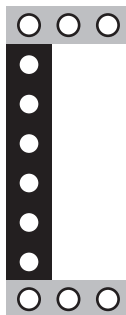

3 Delete the 8 position header. The two 3 position headers are now 17.78mm (0.7") apart from each other.

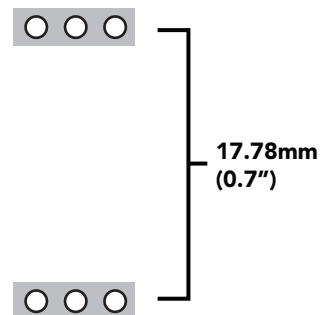

Datasheet change log

Datasheet V 3.2

Revised response for the sleep command in UART mode on pg 36.

Datasheet V 3.1

Added more information on the Export calibration and Import calibration commands.

Datasheet V 3.0

Changed "Max rate" to "Response time" on cover page.

Datasheet V 2.9

Removed note from certain commands about firmware version.

Datasheet V 2.8

Added information to calibration theory on pg 9.

Datasheet V 2.7

Revised definition of response codes on pg 45.

Datasheet V 2.6

Updated calibration processing delay time on pg.51.

Datasheet V 2.5

Revised Plock pages to show default value.

Datasheet V 2.4

Added new commands:

"Find" pages 22 & 49.

"Export/Import calibration" pages 26 & 52.

Added new feature to continous mode "C,n" pg 23.

Datasheet V 2.3

Added manual switching to UART information on pg. 59.

Datasheet V 2.2

Revised Baud command information on pg. 33.

Datasheet V 2.1

Revised entire datasheet.

Firmware updates

V1.02 – Plock (March 31, 2016)

- Added protocol lock feature “Plock”

V1.03 – EEPROM (April 26, 2016)

- Fixed bug where EEPROM would get erased if the circuit lost power 900ms into startup

V1.11 – Bug Fix (June 9, 2016)

- Fixed bug where a blank name would result in garbage output

V2.01 – Update (January 1, 2017)

- Replaced command “response” with “*OK”
- Replaced command “Serial” with “Baud”

V2.02 – Bug Fix (February 16, 2017)

- Fixed bug where calibration would not accept floating point numbers.

V2.10 – (May 9, 2017)

- Added “Find” command.
- Added “Export/import” command.
- Modified continuous mode to be able to send readings every “n” seconds.
- Sleep current is lowered.

Warranty

Atlas Scientific™ Warranties the EZO™ class RTD circuit to be free of defect during the debugging phase of device implementation, or 30 days after receiving the EZO™ class RTD circuit (which ever comes first).

The debugging phase

The debugging phase as defined by Atlas Scientific™ is the time period when the EZO™ class RTD circuit is inserted into a bread board, or shield. If the EZO™ class RTD circuit is being debugged in a bread board, the bread board must be devoid of other components. If the EZO™ class RTD circuit is being connected to a microcontroller, the microcontroller must be running code that has been designed to drive the EZO™ class RTD circuit exclusively and output the EZO™ class RTD circuit data as a serial string.

It is important for the embedded systems engineer to keep in mind that the following activities will void the EZO™ class RTD circuit warranty:

- Soldering any part of the EZO™ class RTD circuit.
- Running any code, that does not exclusively drive the EZO™ class RTD circuit and output its data in a serial string.
- Embedding the EZO™ class RTD circuit into a custom made device.
- Removing any potting compound.

Reasoning behind this warranty

Because Atlas Scientific™ does not sell consumer electronics; once the device has been embedded into a custom made system, Atlas Scientific™ cannot possibly warranty the EZO™ class RTD circuit, against the thousands of possible variables that may cause the EZO™ class RTD circuit to no longer function properly.

Please keep this in mind:

- 1. All Atlas Scientific™ devices have been designed to be embedded into a custom made system by you, the embedded systems engineer.**
- 2. All Atlas Scientific™ devices have been designed to run indefinitely without failure in the field.**
- 3. All Atlas Scientific™ devices can be soldered into place, however you do so at your own risk.**

Atlas Scientific™ is simply stating that once the device is being used in your application, Atlas Scientific™ can no longer take responsibility for the EZO™ class RTD circuits continued operation. This is because that would be equivalent to Atlas Scientific™ taking responsibility over the correct operation of your entire device.