

VCC=3.6V

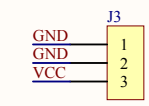
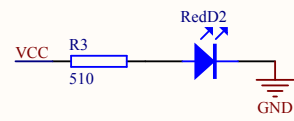
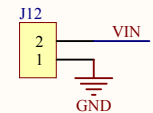
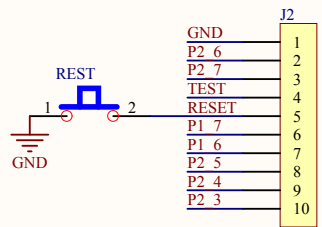
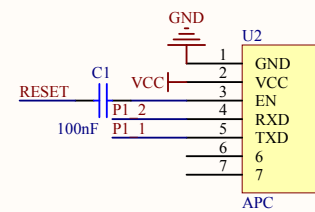
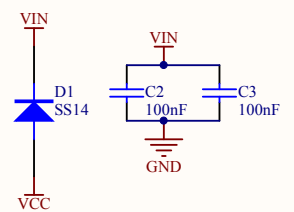
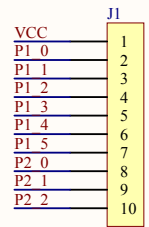
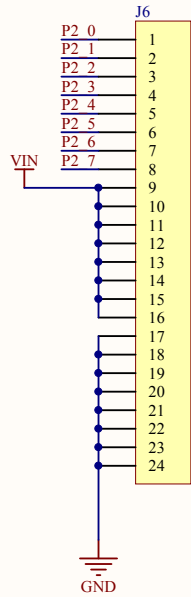
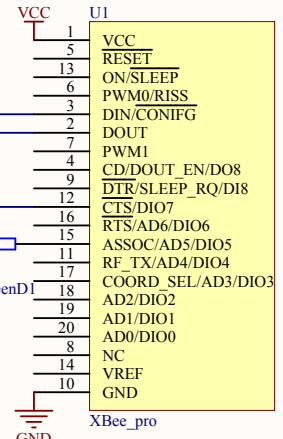
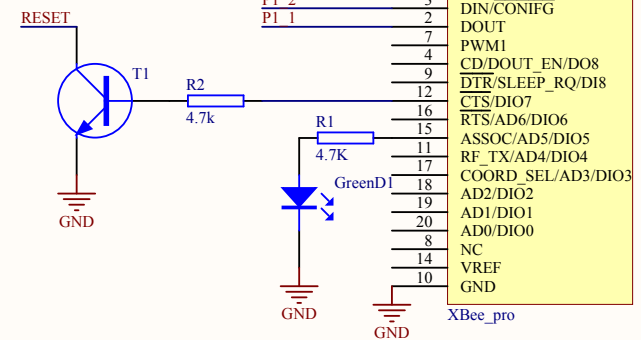
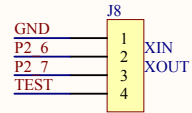
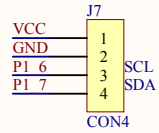
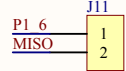
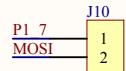
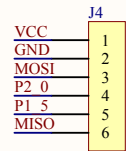
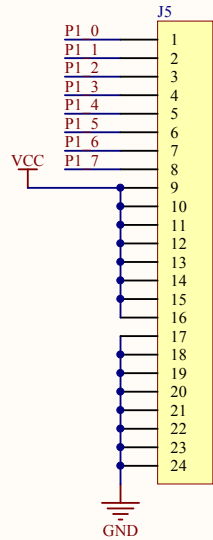

Title		
I/O Expansion Shield for Launchpad		
Size	Number	Revision
A4		V1
Date:	2013/7/19	Sheet of
File:	F:\02-PCB \Launchpad IO Expansion Shield V1.SchDoc	